

OPERATOR'S MANUAL

**LeCROY DIGITAL OSCILLOSCOPES
9350/54 SERIES**

ary 1996

TABLE OF CONTENTS

INTRODUCTION

1 Key Features

2 General Information

Initial Inspection	2-1
Warranty	2-1
Product Assistance.....	2-1
Maintenance Agreements.....	2-2
Documentation Discrepancies.....	2-2
Service Procedure.....	2-2
Return Procedure	2-2

3 Instrument Architecture

Architecture.....	3-1
ADCs and Memories.....	3-2
Trigger.....	3-3
Automatic Calibration	3-3
Display	3-3
Manual/Remote Control	3-3

4 Installation

Operating Environment.....	4-1
Power Requirements.....	4-1
Safety Information	4-1
Power On.....	4-2

5 Front-panel Overview

6 Control of the Oscilloscope

Active Buttons.....	6-1
Switching between Menus	6-1
Performing Actions	6-1
Setting Menu Options.....	6-2
General Instrument Reset.....	6-2

DISPLAY

7 Display Overview

Real-Time Clock Field (1)	7-1
Displayed Trace Field (2)	7-1
Trigger Level Field (3)	7-1
Acquisition Summary Field (4)	7-2
Trigger Delay Field (5)	7-2
Trigger Configuration Field (6)	7-2
Time and Frequency Field (7)	7-2
Trigger Status Field (8)	7-2
Grid (9)	7-3
Menu Field (10)	7-3
Message Field (11)	7-3

TIMEBASE + TRIGGER

8 Timebase + Trigger Capabilities

Timebase Capabilities	8-1
Single Shot	8-1
Peak Detect	8-2
Random Interleaved Sampling	8-2
Roll Mode	8-3
Sequence Mode	8-3
Trigger Capabilities	8-5
EDGE Trigger	8-5

9 Timebase + Trigger Direct Controls

STOP	9-1
AUTO	9-1
NORM	9-2
SNGL	9-2
AUTO SETUP	9-2
DELAY	9-3
ZERO	9-3
TIME/DIV	9-3
LEVEL	9-3
TIMEBASE SETUP	9-3
TRIGGER SETUP	9-3

TABLE OF CONTENTS

10 Timebase Setup

- Timebase Setup Menu 10-1
- More on Channel Use 10-2
- Sequence Mode 10-3
- External Clock..... 10-5

11 Trigger Setup

- Trigger Setup Menu..... 11-1
- How the Trigger Modes Overlap 11-1
- Choosing the Trigger Mode 11-1
- EDGE Trigger 11-2
 - Trigger Symbols 11-3
- SMART Trigger 11-4
 - GLITCH Trigger..... 11-5
 - Interval Trigger 11-8
 - TV Trigger..... 11-10
 - State-Qualified Trigger..... 11-13
 - Edge-Qualified Trigger..... 11-15
 - Dropout Trigger 11-17
 - Pattern Trigger..... 11-19
 - Trigger Symbols 11-22

CHANNELS

12 Channels Direct Controls

- 2-Channel Oscilloscopes
 - Trace ON/OFF 12-1
 - Offset..... 12-1
 - Find 12-1
 - Volts/Div..... 12-1
 - VAR..... 12-1
 - Coupling..... 12-2
- 4-Channel Oscilloscopes
 - Trace ON/OFF 12-3
 - Select Channel 12-3
 - Offset..... 12-3
 - Find 12-3
 - Volts/Div..... 12-4
 - VAR..... 12-4
 - Coupling..... 12-4

13 Coupling

Coupling Menu 13-1
ProBus System 13-2
More on Coupling 13-3
Probes 13-3

ZOOM + MATH

14 Zoom + Math Capabilities

Zoom 14-1
Waveform Mathematics 14-2

15 Zoom + Math Direct Controls

Trace ON/OFF 15-1
Select Trace 15-1
⇔ Position 15-1
⇕ Position 15-1
⇔ Zoom 15-2
⇕ Zoom 15-2
Reset 15-2
Math Setup 15-2

16 Math Setup

Math Setup Menu 16-1
How to use Math 16-1
Standard and Optional Processing Packages 16-1
Setup Menu for Zoom 16-3
Setup Menu for Arithmetic 16-4
Setup Menu for Average 16-5
Setup Menu for Enhanced Resolution 16-7
Setup Menu for Extrema 16-8
Setup Menu for FFT 16-10
FFT Interruption (Abort) 16-10
Setup Menu for FFT Average 16-11
Setup Menu for Functions 16-12
Setup Menu for Rescale 16-14

MENU CONTROLS

17 Menu Buttons & Knobs

Menu Buttons.....	17-1
Menu Knobs.....	17-1
DISPLAY.....	17-2
UTILITIES.....	17-2
WAVEFORM STORE.....	17-2
WAVEFORM RECALL.....	17-2
CURSORS/MEASURE.....	17-2
PANEL SETUPS.....	17-2
SCREEN DUMP.....	17-2
SHOW STATUS.....	17-3
CLEAR SWEEPS.....	17-3
General Instrument Reset.....	17-3

18 Display

Display Menu.....	18-1
Standard Display vs. XY Display.....	18-1
Persistence Display.....	18-2
Screen Presentation.....	18-3
Standard Display.....	18-5
XY Display.....	18-6
Persistence.....	18-7

19 Utilities

Utilities Menu.....	19-1
Hardcopy Setup Menu.....	19-2
Internal Printer Setup Menu.....	19-3
Time/Date Menu.....	19-4
GPIB & RS232 Menu.....	19-5
RS-232-C Connector.....	19-6
Mass Storage File System.....	19-7
Mass Storage Menu.....	19-11
Storage Media Menu.....	19-12
Floppy Menu.....	19-13
Template and Formatting Menu.....	19-14
File Transfers Menu.....	19-15

	Preferences Menu	19-16
	File Name Preferences Menu	19-17
	New Directory Menu	19-18
	Special Modes Menu	19-19
	Reference Clock Menu	19-20
	CAL BNC Out Menu	19-21
20	Waveform Store	
	Waveform Store Menu	20-1
21	Waveform Recall	
	Waveform Recall Menu	21-1
	Recall from Internal Memory	21-1
	Recall from Storage Device	21-2
22	Cursors/Measure	
	Cursors in Standard Display	22-1
	Cursors in Persistence Display	22-1
	Cursors in XY Display	22-1
	Automatic Measurements	22-3
	Pass/Fail	22-3
	Parameter Information & Warning Symbols	22-6
	Cursors Menu	22-7
	Parameters Menu	22-8
	Standard Voltage Parameters	22-9
	Standard Time Parameters	22-10
	Custom Parameters	22-11
	Adding/Deleting Custom Parameters	22-12
	Parameters Requiring Setup	22-13
	Parameters Requiring Setup (Customize)	22-14
	Pass/Fail Testing	22-15
	Pass/Fail Menu	22-16
	Change Test on Parameters	22-17
	Change Limits for Test on Parameters	22-18
	Change Test on Mask	22-19
	Generate Mask from Waveform	22-20
	Recall Mask from Mass Storage Device	22-21
	Set Pass/Fail Actions	22-22

TABLE OF CONTENTS

23 Panel Setups

Panel Setups Menu 23-1
Recall Setup Menu 23-2
Recall Setup from Card, Floppy or Hard Disk 23-3

24 Show Status

Acquisition Summary 24-1
System Summary 24-2
Text & Times Summary 24-3
Waveform Summary 24-4
Memory Used Summary 24-5

Appendix A Specifications

Appendix B Enhanced Resolution

Appendix C Fast Fourier Transform (FFT)

Appendix D Parameter Measurement Methods

DECLARATION OF CONFORMITY

Time: LeCroy SA
LeCroy Corporation
Address: 2, rue du Pré-de-la-Fontaine
CH-1217 Meyrin
Switzerland
700 Chestnut Ridge Road
Chestnut Ridge, NY 10977
USA

On its sole responsibility, the products listed below, including all their
Directive 89/336/EEC for Electromagnetic Compatibility. Compliance
is stated to the following specifications, listed in the Official Journal of
Communities.

LeCroy Digital Oscilloscope

9350A, 9350AM, 9350AL
9354A, 9354AM, 9354AL, 9354TM

Emissions EN 55022: 1994, Radiated Emissions Class B
EN 55022: 1994, Conducted Emissions Class B

Immunity IEC 1000-4-2: 1995, Electrostatic Discharges
IEC 1000-4-3: 1995, RF Electromagnetic Field
IEC 1000-4-4: 1995, Fast Electrical Transients

January 10, 1996

J.-P. Vittet
T&M Engineering



INTRODUCTION

The LeCroy 9350 series digital oscilloscopes provide a set of powerful features for a wide range of applications. Not only do they allow two- or four-channel simultaneous, high speed single-shot capture, but their extensive capabilities and 10 GS/s repetitive sampling make them invaluable as fast, general-purpose oscilloscopes as well.

The oscilloscopes' key features include:

- 500 MHz bandwidth.
- Up to 2 GS/s digitizing rate for transient signals (up to 1 GS/s on 2-channel models).
- 10 GS/s digitizing rate for repetitive signals.
- 25k, 100k (M models) or 2M (L models) of acquisition memory per channel.
- Memory can be combined to achieve up to 8M (up to 4M on 2-channel instruments) of acquisition memory.
- Advanced peak-detect system, synchronous to standard acquisition mode.
- Advanced triggering capabilities including Pattern and Glitch trigger.
- Automatic waveform measurements.
- Automatic Pass/Fail testing.
- Choice of PCMCIA Memory Card, PCMCIA Hard Disk, or DOS Floppy mass storage options.
- Vertical resolution up to 11 bits.
- High-resolution display (810 x 696).
- Built-in printer (option).
- ProBus™ intelligent probe system.

It is recommended that the shipment be thoroughly inspected immediately upon delivery to the purchaser. All material in the container should be checked against the enclosed Packing List. LeCroy cannot accept responsibility for shortages in comparison with the Packing List unless notified promptly. If the shipment is damaged in any way, please contact the Customer Service Department or local field office immediately.

LeCroy warrants its oscilloscope products to operate within specifications under normal use for a period of three years from the date of shipment. A yearly calibration is recommended to ensure in-spec performance. Spares, replacement parts and repairs are warranted for 90 days. The instrument's firmware is thoroughly tested and thought to be functional, but is supplied "as is" with no warranty of any kind covering detailed performance. Products not manufactured by LeCroy are covered solely by the warranty of the original equipment manufacturer.

In exercising this warranty, LeCroy will repair or, at its option, replace any product returned to the Customer Service Department or an authorized service facility within the warranty period, provided that the warrantor's examination discloses that the product is defective due to workmanship or materials and that the defect has not been caused by misuse, neglect, accident or abnormal conditions or operation.

The purchaser is responsible for transportation and insurance charges for the return of products to the servicing facility. LeCroy will return all in-warranty products with transportation prepaid.

This warranty is in lieu of all other warranties, expressed or implied, including but not limited to any implied warranty of merchantability, fitness, or adequacy for any particular purpose or use. LeCroy shall not be liable for any special, incidental, or consequential damages, whether in contract or otherwise.

- ⋮ Answers to questions concerning installation, calibration, and use of LeCroy equipment are available from the Customer Care Center, 700 Chestnut Ridge Road, Chestnut Ridge, New York 10977-6499, U.S.A., tel. (914) 578-6020, and 2, rue du Pré-de-la-Fontaine, 1217 Meyrin 1, Geneva, Switzerland, tel. (41) 22/719 21 11, or your local field engineering office.

LeCroy offers a selection of customer support services. Maintenance agreements provide extended warranty and allow the customer to budget maintenance costs after the initial three-year warranty has expired. Other services such as installation, training, enhancements and on-site repairs are available through specific Supplemental Support Agreements.

LeCroy is committed to providing state-of-the-art instrumentation and is continually refining and improving the performance of its products. While physical modifications can be implemented quite rapidly, the corrected documentation frequently requires more time to produce. Consequently, this manual may not agree in every detail with the accompanying product. There may be small discrepancies in the values of components for the purposes of pulse shape, timing, offset, etc., and, occasionally, minor logic changes. Where any such inconsistencies exist, please be assured that the unit is correct and incorporates the most up-to-date circuitry. In a similar way the firmware may undergo revision when the instrument is serviced. Should this be the case, manual updates will be made available as necessary.

Products requiring maintenance should be returned to the Customer Service Department or authorized service facility. LeCroy will repair or replace any product under warranty at no charge. The customer is responsible for transportation charges to the factory. All in-warranty products will be returned to the customer with transportation prepaid.

For all LeCroy products in need of repair after the warranty period, the customer must provide a Purchase Order Number before repairs can be initiated. The customer will be billed for parts and labor for the repair, as well as for shipping.

To determine your nearest authorized service facility, contact the Customer Service Department or your field office. All products returned for repair should be identified by the model and serial numbers and include a description of the defect or failure, name and phone number of the user, and, in the case of products returned to the factory, a Return Authorization Number (RAN). The RAN may be obtained by contacting the Customer Care Center in New York, tel. (914) 578-6020, in Geneva, tel. (41) 22/719 21 11, or your nearest sales office.

INTRODUCTION

Return shipments should be made prepaid. LeCroy will not accept C.O.D. or Collect Return Shipments. Air-freight is generally recommended. Wherever possible, the original shipping carton should be used. If a substitute carton is used, it should be rigid and be packed such that the product is surrounded with a minimum of four inches of excelsior or similar shock-absorbing material. In addressing the shipment, it is important that the Return Authorization Number be displayed on the outside of the container to ensure its prompt routing to the proper department within LeCroy.

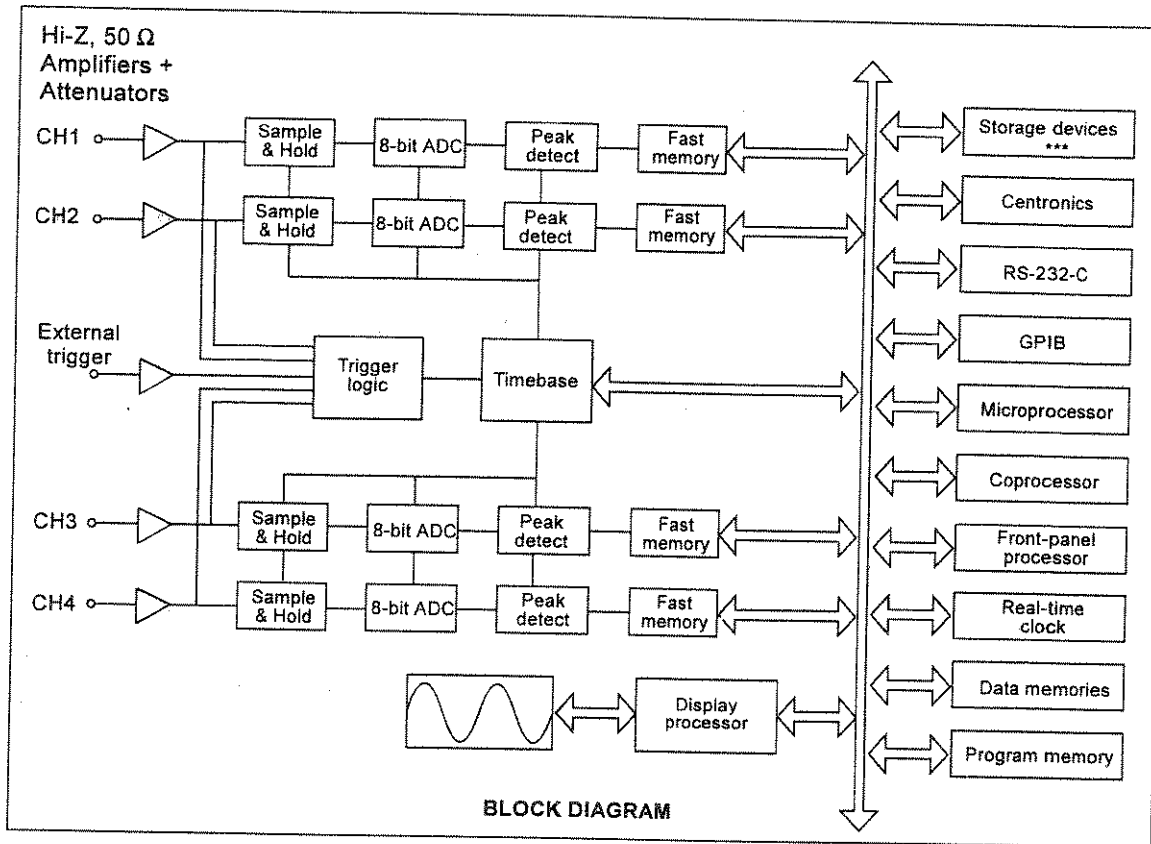

ADCs AND MEMORIES

Each of the oscilloscope's identical input channels is equipped with a 500 MS/s, 8-bit ADC. This multiple ADC architecture ensures absolute amplitude and phase correlation, maximum ADC performance for multi-channel acquisitions, large record lengths and excellent time resolution. In addition, faster sample rates can be achieved by combining two or four channels, bringing the sample rate to a maximum of 1 GS/s on 2-channel models and 2 GS/s on 4-channel models.

Acquisition memories of up to 2M-points simplify transient capture by providing long waveform records that capture waveforms even when trigger timing or signal speed is uncertain. More acquisition memory (up to 4M on 2-channel models, up to 8M on 4-channel models) can be achieved by combining two or four channels. In addition, a special

expansion facility magnifies waveforms by up to 20000 times the selected timebase speed.

Repetitive signals can be acquired and stored at a Random Interleaved Sampling (RIS) rate of 10 GS/s. RIS is a high-precision digitizing technique that enables measurement of repetitive signals to the instrument's full bandwidth, with an effective sampling interval of 100 ps and measurement resolution of 10 ps. (See Chapter 8, "Timebase + Trigger Capabilities").

TRIGGER

The digitally-controlled trigger system offers an extensive range of trigger capabilities. Front-panel and menu controls allow selection of the appropriate trigger function for the signal.

In the standard trigger mode the front-panel controls are used to select and set parameters such as pre- and post-trigger recording, sequence and roll modes, in addition to the Auto, Normal and Single modes. The trigger source can be any of the input channels, line or external. The coupling is selected from AC, LF REJECT, HF REJECT, HF, and DC, and the slope from positive, negative, and window. (See Chapter 8, Timebase + Trigger Capabilities).

AUTOMATIC CALIBRATION

The oscilloscope has an automatic calibration facility that ensures overall vertical accuracy of $\pm 2\%$ of full scale. Vertical gain and offset calibration take place each time the Volts/div is modified. In addition, periodic calibration is performed to ensure long term stability at the current setting.

DISPLAY

The large 12.5 × 17.5 cm (9-inches diagonal) screen displays waveforms with enhanced resolution and serves as an interactive, user-friendly interface via a set of pushbuttons located immediately to the right of the CRT.

The oscilloscope displays up to four waveforms, while simultaneously reporting the parameters controlling signal acquisition. The screen also presents internal status and measurement results, as well as operational, measurement, and waveform analysis menus.

A hard copy of the screen is available via the unit's front-panel screen-dump button.

MANUAL/REMOTE CONTROL

The layout of the front-panel and operation will be very familiar to users of analog oscilloscopes. The "analog" feel is emphasized by rapid instrument response and the fact that waveforms are presented instantly on the high-resolution screen.

The oscilloscope has also been designed for remote control operation in automated testing and computer-aided measurement applications. The entire measurement process, including cursor and pulse parameter settings, dynamic modification of front-panel settings, and display organization, can be controlled via the rear-panel GPIB (IEEE-488) and RS-232-C ports.

Four front-panel setups can be stored and recalled either manually or by remote control, thus ensuring rapid front-panel configuration. When the power is switched off, the current front-panel setting is automatically stored for subsequent recall at the next power-on.

OPERATING ENVIRONMENT

The oscilloscope will operate to its specifications if the environment is maintained within the following parameters:

- Temperature 5° to 40° C (41° to 104° F)
- Humidity <80%
- Operating category II

POWER REQUIREMENTS

The oscilloscope operates from a 115 V (90 to 132 V) or 220 V (180 to 250 V) normal power source at 45 Hz to 66 Hz. No voltage selection is required since the instrument automatically adapts to the line voltage which is present.

The instrument operates at line frequencies up to 440 Hz. However, the leakage current from phase to ground slightly exceeds the safety recommendations for industrial instruments in some countries. This current reaches 4 mA max. at 250 V/400 Hz.

The power supply of the oscilloscope is protected against short circuits and overload by means of two 6.3/250 V fuses. The fuses are located above the mains plug.

Remove the power cable before changing or inspecting a fuse. Open the fuse box by inserting a small screwdriver under the plastic cover and prying it open.

SAFETY INFORMATION

Any use of this instrument in a manner not specified by the manufacturer may impair the instrument's safety protection.

The oscilloscope has been designed to operate from a single-phase power source with one of the current-carrying conductors (neutral conductor) at ground (earth) potential. However, operation from power sources in which both current-carrying conductors are live with respect to ground (such as phase-to-phase on a tri-phase system) is also possible, as the oscilloscope is equipped with over-current protection for both mains conductors. None of the current-carrying conductors may exceed 250 V RMS with respect to ground potential. The oscilloscope is provided with a three-wire electrical cord containing a three-terminal polarized plug for mains voltage and safety ground connection. The plug's ground terminal is connected directly to the frame of the unit. For adequate protection against electrical hazard, this plug must be inserted into a mating outlet containing a safety ground contact.

POWER ON

The oscilloscope has not been designed to make direct measurements on the human body. Users who connect a LeCroy oscilloscope directly to a person do so at their own risk.

Connect the oscilloscope to the power outlet and switch it on by pressing the power switch located on the rear panel. After the instrument is switched on, auto-calibration is performed and a test of the oscilloscope's ADCs and memories is carried out. The full testing procedure takes approximately 10 seconds, after which time a display will appear on the screen.

See front-panel foldout at the beginning of the manual.

TIMEBASE & TRIGGER CONTROLS allow direct adjustment of Time/Div, Trigger Level and Trigger Delay. The **AUTOSETUP** button automatically adjusts the oscilloscope to acquire and display signals on the input channels.

CHANNEL CONTROLS allow selection of displayed traces and adjustment of vertical sensitivity and offset. The **FIND** button automatically adjusts the sensitivity and offset to match the input signal.

The **MEMORY CARD INTERFACE** allows fast and convenient storage of waveforms and instrument setups.

ZOOM & MATH CONTROLS allow you to move, define and expand a trace. (The **SELECT ABCD** button is used to select a trace).

MENU BUTTONS & KNOBS allow easy control of the most sophisticated tasks.

CHANNEL INPUTS have selectable input impedance of $50\ \Omega$ or $1\ M\Omega$ over the entire sensitivity range. **PROBUS™** probe interface supports a wide range of optional probes.

DISPLAY – High-resolution 9-inch screen.

Many of the most commonly used controls can be directly accessed using the labelled pushbuttons and rotary knobs on the front panel. Activating these controls usually causes an immediate visible action. The dark-grey buttons, together with the SHOW STATUS buttons, all give access to menus which have similar behavior. These are the MENU ENTRY keys. They turn on menus on the right-hand side of the display. These menus allow further control of the acquisition, processing, and display modes of the instrument. The SHOW STATUS button gives access to a series of displays summarizing the status of the acquisition, the instrument, and the waveforms.

ACTIVE BUTTONS

Menu buttons which are active have boxes drawn around their accompanying texts on the screen. Other texts are for information only and the corresponding buttons are not used. There are seven menu buttons. The lower two buttons also have associated knobs.

SWITCHING BETWEEN MENUS

Printer
Setup

Any time a MENU ENTRY key is pressed, the instrument immediately displays the current configuration. This menu becomes the new primary menu.

Some of these primary menus have secondary menus under them. The heavy outline of the box associated with the button shows that there is a hidden menu behind it. Pushing the button will cause the appropriate secondary menu to be shown.

Whenever the RETURN button is pressed, the previous primary menu is shown. If the current menu is a primary menu then the menu will be switched off.

When the oscilloscope is put under remote control, the REMOTE ENABLE menu will be shown. It will contain a button "GO TO LOCAL" if this action is allowed. This is the only manual way to turn the REMOTE ENABLE menu off.

PERFORMING ACTIONS

SET CLOCK
FORWARD ONE
HOUR (SPRING)

While most menu buttons modify a selected variable, some perform specific actions. In this case, the text which accompanies the button is written in all capital letters.

In most cases, the effect of changing a value in a menu causes the appearance of the screen to change because the new value is immediately used to change the acquisition settings or the processing, or for the display to be shown.

SETTING MENU OPTIONS

Auto-Store
 OFF
 Wrap, Fill

Math Type
 Enh. Res
 Extrema
 FFT
 FFTAVG
 Functions

for
 1000
 (sweeps)

holdoff
 153 evts
 OFF Time Evts

trigger on
 Line Field
 266 2

limit
 +2.7 E+00
 2 digits

Many options are controllable via the menu buttons and knobs. When setting up a new configuration, the buttons should be adjusted, starting at the top to allow for the fact that the menu control for one primary option may be different from that of another primary option.

Some "single" buttons have one highlighted field among several in their associated texts. Pressing the button advances the highlighted field. If there is a knob associated with the button, it can also be used to navigate among the choices. If only one choice is shown, the button will not do anything.

There are also "double" buttons with one highlighted field. In this case, pressing the lower button causes the highlight to go forward among the choices whereas pressing the upper button causes the highlight to go backward. The arrow at the side of the button's text shows how the highlight will move. The arrow is missing if the highlight is at the beginning or end of the list of allowed values.

Some button and knob combinations control the value of a continuously adjustable variable. The knob is used to set the value of the variable, while the button may be used to either choose a highlighted field or make a simple change of the value of the variable.

Other button and knob combinations control the value of several continuously adjustable variables. The knob is used to set the value of the variable which is highlighted, while the button is used to choose which variable is to be highlighted.

GENERAL INSTRUMENT RESET

To reset the instrument, simultaneously press the AUTO SETUP button, the top menu-button, and the RETURN button. The instrument will revert to its default power-up settings.

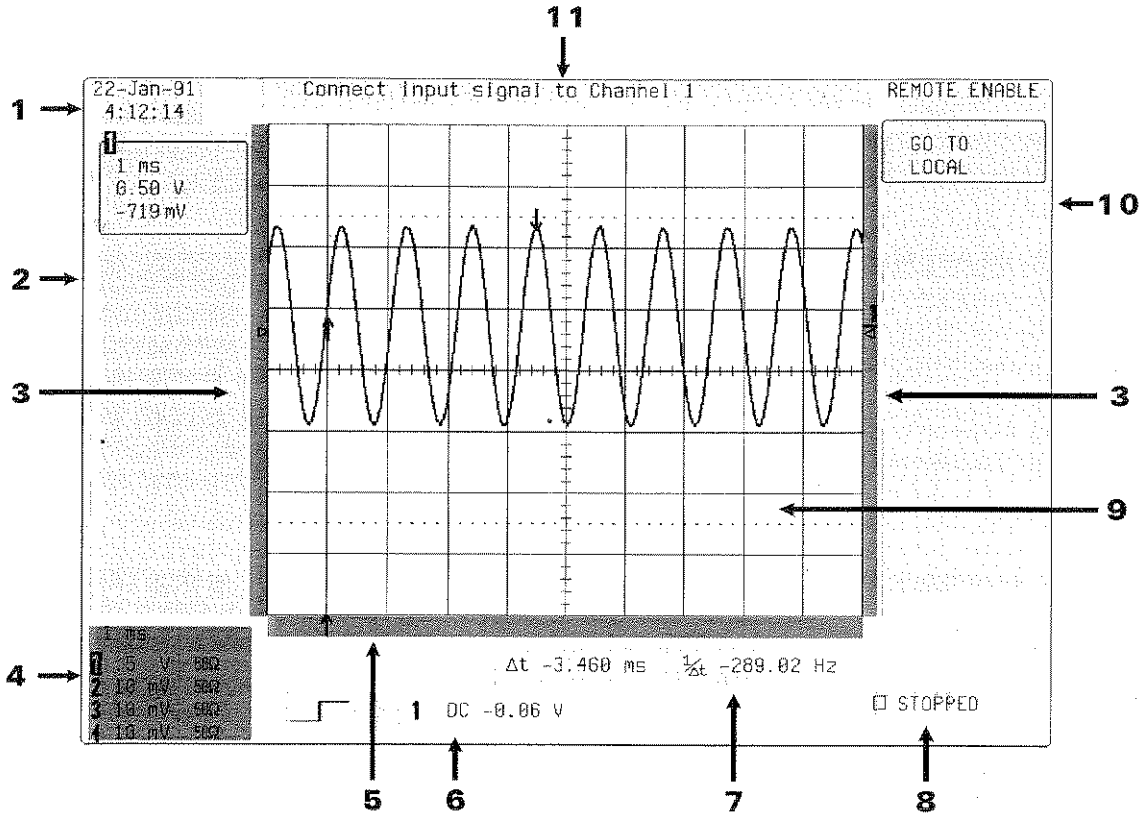

REAL-TIME CLOCK FIELD (1)

Displays the current date and time provided by a battery-backed real-time clock.

DISPLAYED TRACE LABEL FIELD (2)

Contains the identity of the displayed trace, its timebase and Volts/div settings, and cursor readings when applicable. Up to four traces can be shown simultaneously.

TRIGGER LEVEL FIELD (3)

Contains the trigger level indicator on both sides of the grid, and the ground indicator for each channel on the right side of the grid.

**ACQUISITION SUMMARY
FIELD (4)**

Contains the common timebase setting and, for each channel, the vertical gain, probe attenuation and coupling. For 4-channel instruments, the currently selected channel is highlighted.

Note: The displayed trace field shows the acquisition parameters that were set when the trace was captured or processed, whereas the acquisition summary indicates the present setting.

TRIGGER DELAY FIELD (5)

Indicates the trigger delay (arrow symbol) with respect to the left-hand edge of the grid. The delay can be adjusted from 0 to 10 divisions (pre-trigger) or from 0 to -10000 screen divisions (post-trigger). Pre-trigger delay appears as an upward arrow at the appropriate position in the field. Post-trigger is given as a delay in seconds.

When the relative-time cursors (two arrow cursors) are active (selected in MEASURE menu), this field displays the time interval between the two cursors. It also displays the frequency corresponding to $1/(\text{time interval})$.

**TRIGGER CONFIGURATION
FIELD (6)**

Displays the trigger source, slope, level and coupling. When applicable, additional information is given (hold-off by time or by number of events, logic states, etc...). A simple icon gives an overview of the trigger conditions.

**TIME AND FREQUENCY
FIELD (7)**

This field displays time and frequency relative to cursors; e.g. when the absolute-time cursor (cross-hair cursor) is active (selected in MEASURE menu), this field displays the time between the cursor and the trigger point.

TRIGGER STATUS FIELD (8)

Indicates the trigger re-arming status (AUTO, NORMAL, SINGLE, STOPPED).

During an acquisition the little box at the left of the re-arming status will indicate when an intermediate acquisition occurs. This feature helps to monitor the trigger rate before the waveform is reconstructed.

For NORMAL status, a message SLOW TRIGGER may appear in the field when needed.

For slow acquisition, a message SLOW UPDATE appears, reminding the user that it will take a while before a new waveform will finish.

The region just to the left of the trigger status field can contain messages showing that lengthy processes, such as FFT calculations or screen dumps, are under way.

GRID (9)

Displays traces from the acquisition or reference memories. A dual- or quad-grid presentation can also be selected in the display menu (see Chapter 18).

MENU FIELD (10)

This field is divided into seven sub-fields with menu buttons and two rotary knobs. Each field can display the name of a menu or perform an operation when the associated menu button is pressed. The RETURN button is used to restore the next higher menu level.

MESSAGE FIELD (11)

This field is used to display a variety of messages (warnings, indications, titles, etc...) that explain the instrument's current status.

TIMEBASE CAPABILITIES

Depending on the timebase setting, the following three sampling modes are possible:

- Single Shot
- Random Interleaved Sampling
- Roll Mode

For all timebases for which the single shot mode or roll mode can be used, the acquisition memory can be subdivided into user-defined segments to give:

- Sequence Mode

SINGLE SHOT

Single Shot acquisition is the basic acquisition technique of a digital oscilloscope. Other timebase modes of the oscilloscope make use of this single shot acquisition technique.

An acquired waveform consists of a series of measured voltage values sampled at a uniform rate on the input signal. The acquisition is typically stopped at a fixed time after the arrival of a trigger event as determined by the trigger delay. The acquisition consists of a single series of measured data values associated with one trigger event. The time of the trigger event is measured using the timebase clock. The horizontal position of a waveform is determined using the trigger event as the definition of time 0. Waveform display is also done with this definition. Since each channel has its own ADC, the voltage on each of the input channels is sampled and measured at the same instant. This allows very reliable time measurements between different channels.

Trigger delay can be selected anywhere in a range that allows the waveform to be sampled from well before the trigger event up to the moment it occurs (100% pretrigger), or at a time starting at the equivalent of 10000 divisions (at the current Time/div) after the trigger.

For fast timebase settings the maximum single shot sampling rate of the ADC's is used; this is 500 MegaSamples per second¹. As the timebase is slowed down, more and more data samples are used to fill the waveform until the maximum memory size of the waveform has been reached. For timebases slower than this, the sampling rate is decreased while maintaining the number of data samples in the

¹ On one and each channel. Higher sampling rates can be achieved by combining channels. See Appendix A.

waveform. Single shot acquisition is allowed for all timebase ranges slower than 10 ns/div.

PEAK DETECT

When using slow timebases, sample rate decreases as mentioned above, and very short events like glitches can be missed if they occur between two samples. To prevent this, a special circuitry – the peak detect system – can be switched on, capturing the signal envelope with a resolution of 2.5 ns, without destroying the underlying data which is captured simultaneously and on which processing (pulse parameters, FFT, averaging) can be performed.

RANDOM INTERLEAVED SAMPLING

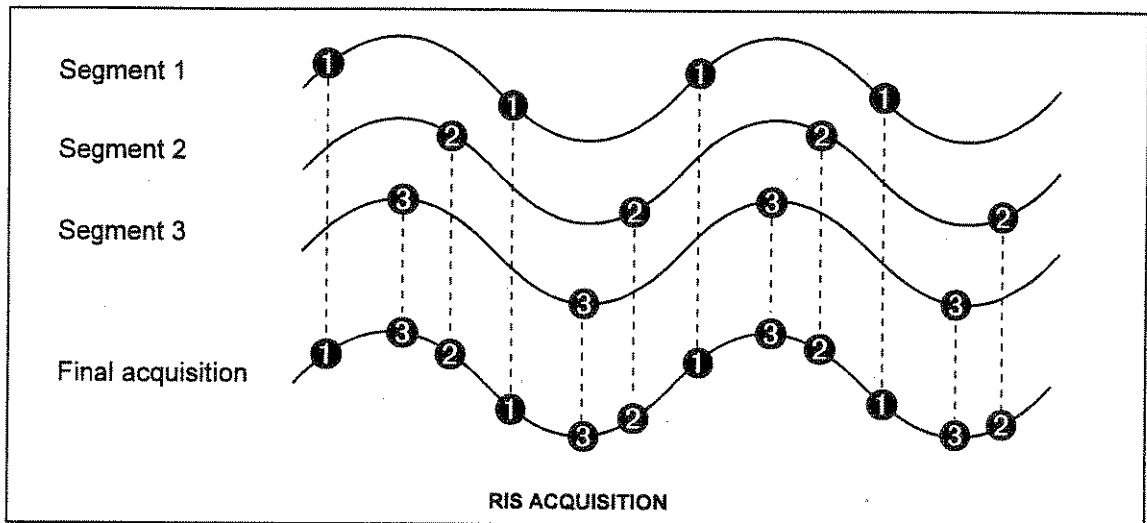

Random Interleaved Sampling (RIS) is an acquisition technique that allows effective sampling rates higher than the maximum single shot sampling rate (500 MS/s)², and is used on repetitive waveforms with a stable trigger.

The maximum effective sampling rate of 10 GS/s can be achieved by acquiring 20 single-shot acquisitions (also called bins) at 500 MHz, with each bin positioned approximately 0.1 ns after the previous one. The process of acquiring 20 bins that satisfy this time constraint is random. The relative time between ADC sampling in-

² On one and each channel. Higher sampling rates can be achieved by combining channels. See Appendix A.

constraint is random. The relative time between ADC sampling instants and the event trigger provides the necessary variation. It is measured by the timebase to 10 ps accuracy.

Typically, 104 trigger events may be needed to complete an acquisition, although sometimes many more are needed. These segments are interleaved to provide a waveform that covers a time interval that is a multiple of the maximum single shot sampling rate. However, the real time interval over which the data for the waveform has been collected is orders of magnitude longer and depends on the trigger rate and the level of interleaving desired. The oscilloscope is capable of acquiring approximately 10000 RIS segments per second.

RIS acquisitions are allowed for timebase settings from 1 ns/div up to the point at which a 1 GS/s (1 ns/point) acquisition fills the available memory. At slower timebase settings there is no need to use the RIS technique.

RIS acquisitions do not have to be "complete" in order to be useful. A RIS acquisition can be stopped manually (STOP) or automatically (AUTO). The oscilloscope can treat RIS waveforms with missing segments.

ROLL MODE

Single shot acquisitions at timebase settings slower than 0.5 s/div (10 s/div for 2M records) have a sufficiently low data rate to allow the display of the incoming points in real time. The oscilloscope shows the incoming data continuously until a trigger event is detected and the acquisition is completed. The latest data is used to update a trace display that moves from right to left, similar to the output of a strip chart recorder.

Waveform MATH and Parameter calculations are done on the completed waveforms. The behavior of the STOP, SNGL, NORM, and AUTO buttons is modified when a roll mode acquisition is being used (see Chapter 9).

SEQUENCE MODE

Sequence mode is an alternative to single shot acquisition, and provides many unique features. The complete waveform consists of a selectable number of fixed-size segments acquired in a single shot mode (see Appendix A for the limits). The dead time between the trigger events for consecutive segments can be kept to 100 μ s as opposed to the hundreds of milliseconds usually required between consecutive single shot waveforms. Complicated sequences of events covering a large time interval can be captured with fine details if there are uninteresting periods between the events. Time meas-

sequence waveform using the full precision of the acquisition timebase. Trigger time stamps are given for each of the segments in the TEXT & TIMES Status menu. Each individual segment can be displayed using the ZOOM capability or be used as input to the MATH package. For remote operation, sequence mode can be used to take full advantage of the high data transmission capability of the oscilloscope by overlapping the transmission of one waveform with the acquisition of its successor.

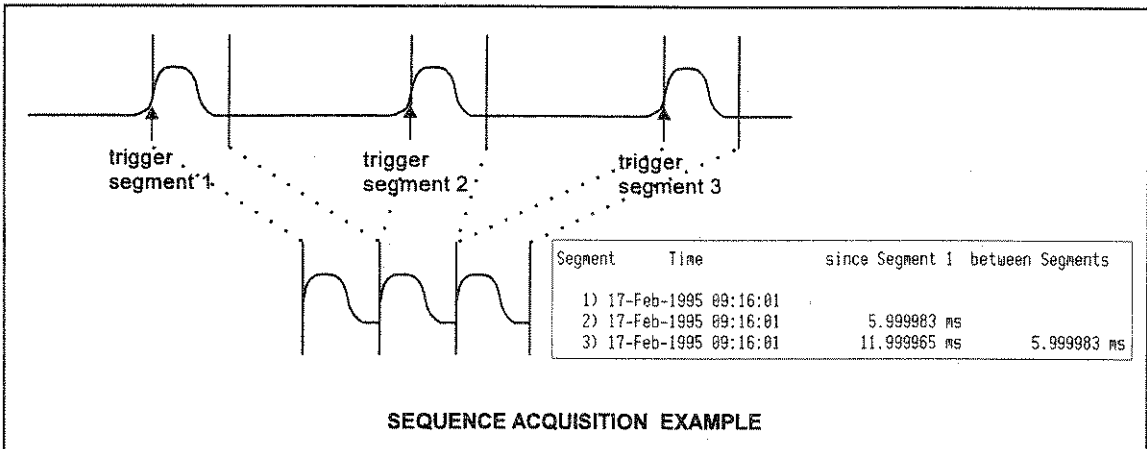

SEQUENCE ACQUISITION EXAMPLE

In sequence mode the timebase setting is used to determine the acquisition duration of each segment, which will be 10 x TIME/DIV. The timebase setting, the desired number of segments, the maximum segment length and the total memory available for the oscilloscope model are used to determine the actual number of samples/segment and time/point to be used. The display of the complete waveform with all of its segments may not entirely fill the screen.

Sequence mode is normally used to acquire the desired number of segments and terminate the waveform acquisition. It can also be used to acquire the segments continuously, overwriting the oldest ones as necessary. Then a manual STOP order or a timeout condition can be used to terminate the waveform acquisition. The behavior of the STOP, SNGL, NORM, and AUTO buttons is modified when a sequence mode acquisition is being used (see Chapter 9). To ensure low dead time between segments, button-pushing and knob-turning must be avoided during acquisition of sequences.

TRIGGER CAPABILITIES

The oscilloscope trigger is used to determine when to stop sampling data. The trigger possibilities have been divided into two classes: :

- **EDGE** – including:
 - simple threshold triggers on an input signal
 - LINE signal triggers
 - triggers with holdoff by time
 - triggers with holdoff by number of trigger events
- **SMART** – including triggers requiring one trigger signal:
 - GLITCH triggers on the pulse width of a trigger signal
 - INTERVAL triggers on the interval between trigger transitions
 - TV triggers for composite video signals
 - DROPOUT trigger for transitions that cease after a while
 - PATTERN trigger on a logical combination of the state of each channel
and
 - Qualified triggers which trigger on one signal after a transition on another signal with possible additional requirements

To capture rare phenomena such as glitches or spikes, missing bits, or intermittent faults, an oscilloscope must be able to trigger on elusive events. The 9350 series of oscilloscopes offer a variety of sophisticated trigger modes. They are based on a counter which can be set by one signal and pre-set, to count a specified number of events of another signal (1 to 10^9), or alternatively to measure time intervals up to 20 s.

A discussion of each of the SMART triggers can be found in Chapter 11, together with instructions on how to set them up.

EDGE TRIGGER

Single Edge triggers are described by a source, coupling, slope, and level condition. These same parameters are used to build up the SMART triggers.

Source is selected from:

- CH1, CH2 (CH3, CH4): the acquisition channel signal conditioned for the overall voltage gain, coupling, and bandwidth as described in Chapters 12 and 13.
- LINE: the line voltage which powers the oscilloscope. It can be used to provide a stable display of signals synchronous with the power line. Coupling and level are not relevant for this selection.

- EXT: the signal applied to the EXT BNC connector. It can be used to trigger the oscilloscope within a range of ± 0.5 V and an input impedance of $1\text{ M}\Omega$ and $50\ \Omega$. (Not applicable if external clock is selected in timebase menu).
- EXT/10: the signal applied to the EXT BNC connector. It can be used to trigger the oscilloscope within a range of ± 5 V and an input impedance of $1\text{ M}\Omega$ and $50\ \Omega$. (Not applicable if external clock is selected in timebase menu).

Coupling refers to the type of signal coupling at the input of the trigger circuit. Note that the trigger coupling can be selected independently for each of the sources. The DROPOUT and Qualified triggers use these selections. Therefore, a change of trigger source may also result in a change of the trigger coupling shown. The coupling choices are:

- DC: All of the signal's frequency components are coupled to the trigger circuit. This coupling mode is used in the case of high-frequency bursts, or where the use of AC coupling would shift the effective trigger level.
- AC: Signals are capacitively coupled; DC levels are rejected and frequencies below 50 Hz are attenuated.
- LF REJ: Signals are coupled via a capacitive high-pass filter network. DC is rejected and signal frequencies below 50 kHz are attenuated. The LF REJ trigger mode is used when stable triggering on medium to high frequency signals is desired.
- HF REJ: Signals are DC coupled to the trigger circuit and a low-pass filter network attenuates frequencies above 50 kHz. The HF REJ trigger mode is used to trigger on low frequencies.
- HF: Used for triggering on high-frequency repetitive signals in excess of 300 MHz. Maximum trigger rates greater than 500 MHz are possible. HF triggering should be used only when needed. It will be automatically overridden and set to AC when it is incompatible with other characteristics of the trigger mode. This is the case for the SMART triggers. Only one slope is available. It will be shown by the trigger symbol.

Slope selects the direction of the trigger voltage transition to be used to generate a trigger event.

The selected slope is associated with a trigger source in the same way as the coupling.

Level defines the source voltage at which the trigger circuit will generate an event. The selected level is associated with a trigger source in the same way as the coupling. Note that the trigger level is specified in volts and is normally unchanged when the vertical gain or offset is modified.

The amplitude of trigger signals and the range of trigger levels are limited as follows:

- ± 5 screen divisions with a channel as trigger source.
- ± 0.5 V with EXT as trigger source.
- ± 5 V with EXT/10 as trigger source.
- None with LINE as trigger source (zero crossing is used).

EDGE Trigger with Holdoff

Holdoff is an additional characteristic of the trigger circuitry. When the Holdoff is OFF, the time between successive trigger events is limited only by the input signal, the coupling, and the oscilloscope's bandwidth.

Sometimes a stable display of complex repetitive waveforms can be achieved by putting a condition on this time. This holdoff is expressed either as a time or an event count. The time is measured starting at one trigger event, and the next event arriving after this time is allowed to trigger the oscilloscope. The event count is the number of trigger events to be ignored after one trigger event until the next one to be allowed. The choice of which holdoff mode is to be used depends on the application. Often, either one can be used to obtain the same result.

It should be noted that the holdoff is started by potential triggers and not at the end of an acquisition. Potential triggers will be accepted if the oscilloscope is ready, but will be ignored if the instrument is still busy handling the previous trigger event. In fact, the holdoff ensures synchronization between successive real triggers.

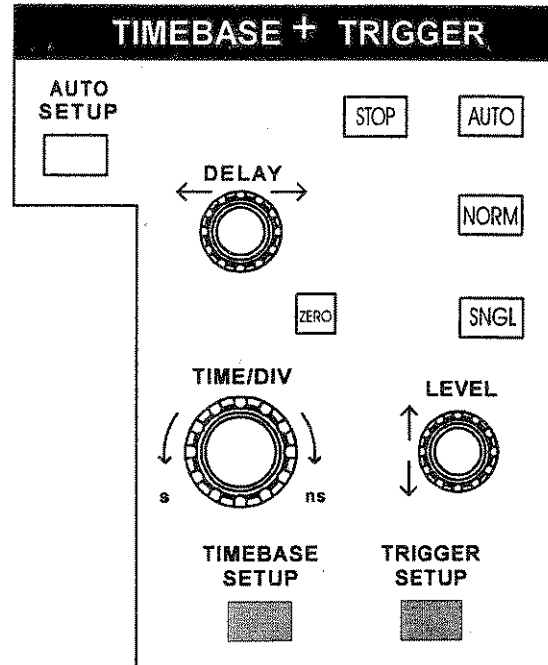
**STOP**

This button is used to halt the acquisition and can be used in all three re-arming modes (AUTO, NORM, SNGL). Pressing the STOP button prevents the oscilloscope from acquiring a new signal.

If the STOP button is pressed while a single-shot acquisition is under way, the last acquired signal will be kept.

If a RIS acquisition has been started, it will be stopped and a partial waveform reconstruction will be performed.

If the acquisition is in the ROLL mode, it will be stopped and the incomplete acquisition data will be shown as if a trigger had occurred.

For Sequence acquisitions, the timebase will be stopped and all the new segments will be shown.

AUTO

In AUTO mode, the oscilloscope automatically displays the signal if NO trigger occurs for more than 500 ms. If a trigger occurs within this time, the oscilloscope behaves as in NORMAL mode.

For the RIS mode, the acquisition will be terminated and shown each second, although some needed segments may be missing.

For the ROLL mode, the oscilloscope samples the input signals continuously and indefinitely. The acquisition has no trigger condition but can be stopped as desired by the user.

For Sequence mode, the acquisition will be terminated if the time between two consecutive triggers exceeds a selectable timeout (see the UTILITIES menu under SPECIAL MODES). The next acquisition is then started from segment 1.

NORM

In this mode the screen is continuously updated as long as a valid trigger is present. If no valid trigger is present, the last signal is preserved and the warning "SLOW TRIGGER" is displayed in the Trigger Status Field.

For the ROLL mode, the acquisition is terminated when the last needed data after a trigger have been taken. The display is paused, showing the entire waveform. After a moment it will go back into the roll mode while it waits for the next trigger.

For the Sequence mode, the acquisition is terminated after the last segment is acquired. The next acquisition is started immediately. A Sequence WRAP mode in NORMal is the same as in SINGLE.

SNGL

In Single Shot mode the instrument waits for one single trigger to occur, then displays the signal and stops acquiring. If no signal occurs, the button can be pressed again to show the signal being observed without a trigger.

When in RIS mode, (selected in TIMEBASE SETUP), the instrument will wait for all the trigger events required to build up ONE signal on screen before it stops (this may require as many as 4000 trigger events).

The ROLL mode is the same as single shot except that there is no need to push the button a second time to show the signal.

AUTO SETUP

This button automatically scales the timebase, trigger level, offset, and Volts/div to provide a stable display of REPETITIVE signals.

Auto-setup rules:

- Auto Setup operates only on channels which are ON. If no channels are ON, then Auto Setup will operate on ALL the channels and will turn them all ON.

- Signals detected must have an amplitude between 2 mV and 40 V, a frequency greater than 50 Hz, and a duty cycle greater than 0.1%.
- If signals are detected on several channels, the channel with the lowest number will determine the selection of the timebase and trigger source.

DELAY

This knob is used to adjust the pre- or post-trigger delay.

Pre-trigger adjustment is available from 0 to 100% of the full time-scale, in steps of 1%. The pre-trigger delay is illustrated by the vertical arrow symbol on the bottom of the grid.

Post-trigger adjustment is available from 0 to 10000 divisions in 0.1 division increments. The post-trigger-delay value is labelled in seconds and is located in the Trigger Delay Field on the screen.

ZERO

Pressing this button causes the trigger delay to be set to zero, i.e. the trigger instant is the left-hand edge of the grid.

TIME/DIV

This knob selects the time per division in a 1-2-5 sequence. The time/div setting is displayed in the Acquisition Summary field.

LEVEL

This knob adjusts the trigger threshold.

The amplitude of trigger signals and the range of trigger levels is limited as follows:

- ± 5 screen divisions with a channel as trigger source
- ± 0.5 V with EXT as trigger source
- ± 5 V with EXT/10 as trigger source
- Inactive with Line as trigger source

The trigger sensitivity is better than 1/3rd of a screen division.

TIMEBASE SETUP

This menu-entry key calls up the "TIMEBASE SETUP" menu described in chapter 10.

TRIGGER SETUP

This menu-entry key calls up the "TRIGGER SETUP" menu described in chapter 11.

TIMEBASE SETUP MENU

The Timebase Setup menu is used to select:

- Single-shot or Interleaved (RIS) acquisition
- External clock
- Channel pairing and Peak Detect
- Sequence mode
- The number of segments in sequence mode
- The maximum record length

The menu also shows the status of:

- The number of points acquired
- The sampling rate
- The total time span

TIMEBASE	
T/div	.1 μ s
	500
samples at	500 Ms/s
	(2 ns/pt)
for	1 μ s
Sampling	
	Single Shot
	RIS
Sample Clock	
	Internal
	ECL 0V TTL
Channel Use	
	2
	Peak-Detect
Sequence	
	OFF On Wrap
Record up to	
	50k
	samples

Sampling

Two essential modes of operation may be selected with this menu button:

- **Single Shot** – the oscilloscope displays data collected during successive single-shot acquisitions from the input channels. This mode allows captures of **non-recurring** or **very low repetition-rate** events **simultaneously** on **all** the input channels.
- **RIS** – the oscilloscope uses a Random Interleaved Sampling technique to achieve a higher effective sampling rate than in single-shot mode, provided the input signal is repetitive and the trigger is stable.

Sample Clock

Selects the sample clock mode (internal or external). See page 10-5.

Channel Use

Selects channel pairing (see following page). Also controls the peak detect mode (see page 8-2).

Sequence

Selects Sequence mode. See page 10-3.

Record up to

Selects the maximum record lengths of the acquisition channels.

MORE ON CHANNEL USE

Channels can be combined to achieve more memory and more sampling rate by interleaving the ADCs in time.

When channels are paired, Channel 1 and Channel 4¹ are disabled and the maximum sampling rate on Channel 2 and Channel 3¹ is 1 GS/s. The maximum record length is also doubled. On 4-channel units and on fast timebases it is possible to achieve 2 GS/s by means of a special adaptor (PP092) placed on Channel 2 and Channel 3. As soon as the PP092 is in place, the oscilloscope interleaves the four 500 MS/s ADCs and the acquisition memory to achieve a maximum sampling rate of 2 GS/s and up to four times the initial record length.

9350/54					
Channels used	Max. sample rate	Memory per channel			Notes
		9350/54	9350/54M	9350/54L	
All Peak Detect OFF	500 MS/s	25k	100k	2M	All channels active
All Peak Detect ON	100 MS/s data 400 MS/s peak	10k data + 10k peaks	50k data + 50k peaks	1M data + 1M peaks	All channels active 2.5 ns peak detect
Paired Peak Detect OFF	1 GS/s	50k	250k	4M	9350: CH1 9354: CH2 + CH3
Paired + PP092 Peak Detect OFF	2 GS/s	100k	500k	8M	9354 models only

9354T/TM				
Channels used	Max. sample rate	Memory per channel		Notes
		9354T	9354TM	
All Peak Detect OFF	500 MS/s	100k	500k	All channels active
All Peak Detect ON	100 MS/s data 400 MS/s peak	50k data + 50k peaks	250k data + 250k peaks	All channels active 2.5 ns peak detect
Paired Peak Detect OFF	1 GS/s	250k	1M	CH2 + CH3
Paired + PP092 Peak Detect OFF	2 GS/s	500k	2M	

¹ 4-channel units only

SEQUENCE MODE**When Sequence is set to ON**

1. If the trigger mode is SINGLE, the oscilloscope fills the segments and stops, or if there are not enough trigger events to fill the segments, it waits forever unless the STOP trigger mode button is pressed.
2. If the trigger mode is NORM, the oscilloscope fills the segments and then, if more trigger events occur, the acquisition is restarted from segment 1.
3. If the trigger mode is AUTO, and if the time between two consecutive triggers exceeds a selectable time-out, the acquisition is restarted from segment 1.

The time-out can be selected in the UTILITIES menu under SPECIAL MODES (Chapter 19).

When Sequence is set to WRAP

The segments are filled continuously until the STOP trigger mode button is pressed. The last N segments will be displayed. An alternative way to stop the WRAP sequence is through AUTO mode; if the time between two consecutive triggers exceeds a selectable time-out, the acquisition will stop.

TIMEBASE + TRIGGER

TIMEBASE
T/div .2 μ s
100 * 1000
samples at
500 MS/s
(2 ns/pt)
for 2.0 μ s
Sampling
Single Shot
Sample Clock
Internal
ECL 0V TTL
Channel Use
1 2
Peak-Detect
Sequence
100 segments
Off On Wrap
Max. segment
2500

Sequence

The menu knob is used to select the desired number of segments.

Max. segment

Selects via the menu knob/button the maximum record length for each segment.

Note: A summary of the acquisition conditions is displayed at the top of the menu: number of segments, available record length per segment, sampling rate, and timebase setting.

EXTERNAL CLOCK

Oscilloscopes fitted with the option CKIO allow the user to supply clock signals at the External TRIG BNC input which will be used to drive the ADCs of the instrument. Additional menu fields allow the choice of the type of external clock signal and the size of the record to be acquired.

TIMEBASE
EXTERNAL
2000000
samples at
200000 s/div
Sampling
Single Shot
Sample Clock
Internal
EXT 0V TTL
External
DC50Ω DC WR
Sequence
OFF On Wrap
Record
2M

Sampling

This button is inactive when the external sample clock is being used. Only single-shot acquisition mode is available.

Sample Clock

Press this button to select the appropriate description of the signal applied to the TRIG BNC connector for use as the sample clock. The rising edge of the signal is used to clock the ADCs of the oscilloscope. The effective thresholds for sampling the input are:

- ECL - -1.3 V
- 0 V - 0.0 V
- TTL - +1.5 V
- RP (Rear Panel) specifies that the 500 MHz external clock connected to the rear panel is to be used as the sample clock.

The risetime and falltime of the signal should both be less than 10 ns.

(Usable only if EXT trigger is not used as the trigger source.)

External

Selects the input coupling for the external clock signal.

Sequence

This button is used to select Sequence Mode if desired. The knob is used to adjust the number of segments. Trigger time stamps are not available when the external clock is in use. The AUTO sequence timeout feature is not available. The intersegment dead time is no longer guaranteed.

Record

Use the knob to select the desired number of samples for the single-shot acquisition.

Notes when using External Clock

The time/div is expressed in s/div which should be thought of as samples/div.

The trigger delay is also expressed in samples and can be adjusted as usual.

No attempt is made to measure the time difference between the trigger and the external clock. Therefore, successive acquisitions of the same signal can appear to jitter on the screen.

The oscilloscope will require a number of pulses (typically 50) before it recognizes the external clock signal. The acquisition is halted only when the trigger conditions have been satisfied and the appropriate number of data points have been accumulated.

Any adjustment to the time/division knob automatically returns the oscilloscope to normal (internal) clock operation.

TRIGGER SETUP MENU

The Trigger Setup menu is used to select:

- The trigger mode
- The Edge trigger settings
- SMART trigger settings that enable triggering on:
 - Glitches
 - Intervals
 - TV signals
 - Edge- or State-qualified events
 - Dropouts
 - Patterns

HOW THE TRIGGER MODES OVERLAP

Once specified, Trigger Level (i.e. threshold) and Trigger Coupling are the only parameters that are passed unchanged from mode to mode – and this is done for each trigger source.

CHOOSING THE TRIGGER MODE

The Trigger Setup menu can be displayed at any time by pushing the dark-grey menu-entry key marked TRIGGER SETUP.

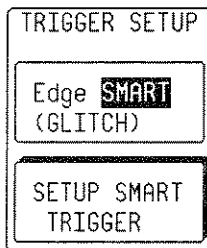

The top menu button allows the choice between EDGE and SMART triggers.

After activating the SMART trigger with the top menu button, all of the parameters for the current SMART trigger are shown for modification in the menu.

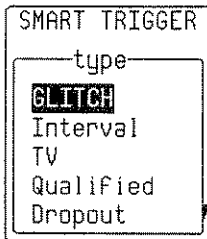

When SMART is selected, the SETUP SMART TRIGGER menu button gives access to a lower level menu where a different SMART trigger can be chosen. The top button in this menu gives the choice of SMART trigger types available.

EDGE TRIGGER

The EDGE mode is used to:

- Select a trigger source
- Select the coupling for each source
- Select the slope (positive or negative)
- Define the holdoff in time or events

TRIGGER SETUP

Edge SMART

trigger on
 1 2 3 4 Ext
 Ext10 Line

coupling 1
 DC AC LFREJ
 HFREJ HF

slope 1
 Pos Neg

holdoff
 1.61 μ s
 Off Time Evt

Edge/SMART

Activates either **Edge** trigger or **SMART** trigger mode.

trigger on

Selects the trigger source in Edge mode.

coupling

Selects the trigger coupling for the current source.

slope

Defines the trigger point to be on either the **positive** or **negative** slope of the selected source.

holdoff

Holdoff disables the oscilloscope's trigger circuit for a definable period of time or number of events *after* a trigger event occurs.

By pressing the holdoff menu button, holdoff can be defined as:

- a period of time
- a number of events (an event being a change in the input signal that satisfies the trigger conditions)

The menu knob is used to vary the "holdoff" value.

Time holdoff values in the range 10 ns – 20 s may be entered.

Event counts in the range 1 – 10⁹ are allowed.

EDGE Trigger Symbols

Trigger Symbols are used to allow immediate recognition of the current trigger conditions. Examples of Edge trigger symbols are given in the following figure. The heavier transitions show where a trigger will be generated.

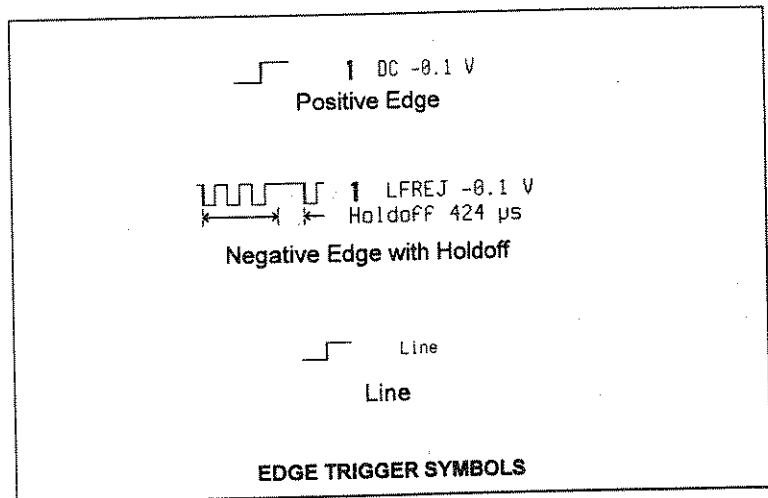

SMART TRIGGER

TRIGGER SETUP
Edge SMART (GLITCH)
SETUP SMART TRIGGER
trigger on 1 2 3 4 Ext Ext10
coupling 1 DC AC LFREJ HFREJ
at end of Neg Pos pulse
width < 7.5 ns OFF On
& width > 2.5 ns OFF On

The following describes the SMART trigger setup menu (called up by pressing the SETUP SMART TRIGGER menu button).

After activating the SMART trigger with the top menu button, all of the parameters for the current SMART trigger are shown for modification in the menu.

The SETUP SMART TRIGGER menu button gives access to a lower level menu where a different SMART trigger can be chosen. The top button in this menu gives the choice of SMART trigger types available (see following pages).

GLITCH Trigger

The GLITCH trigger tests the pulse width – at the trigger level – of the input signal. It is mainly used to trigger on glitches (fast transitions) that may occur in a signal under test.

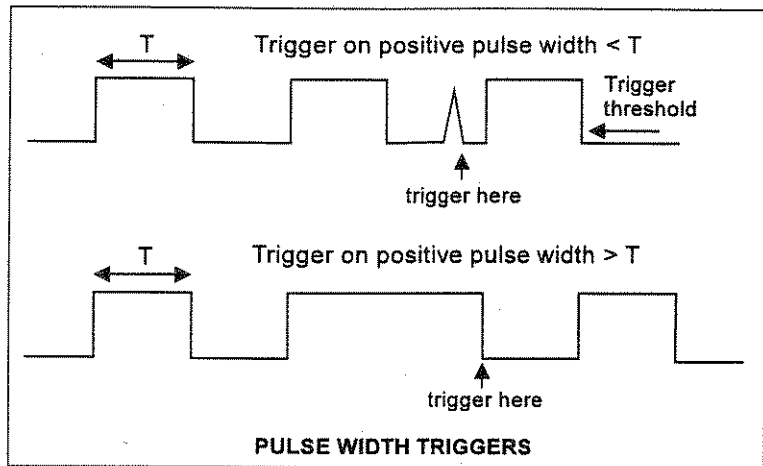

This trigger generates an event at the end of a pulse that satisfies the desired limits on its width. Both negative and positive pulses can be used. The width limits can be chosen as smaller or greater than a given value, within a time window, or outside a time window.

This feature offers a wide range of capabilities for application fields as diverse as digital and analog electronic development, ATE, EMI, telecommunications, and magnetic media studies. Catching elusive rare glitches becomes very easy. In digital electronics, where the circuit under test normally uses an internal clock, a glitch can be theoretically defined as any pulse with a width smaller than the clock period (or half period).

In a broader sense, a glitch can be defined as a pulse much faster than the waveform under observation.

Widths with 2.5 ns resolution starting at a minimum value of 2.5 ns can be selected. For recurrent glitches, the oscilloscope's random interleaved sampling mode allows glitch visualization with an equivalent sampling rate of up to 10 GS/s, i.e. one sample point every 100 ps.

SMART TRIGGER	
type	
<input checked="" type="checkbox"/> GLITCH	
<input type="checkbox"/> Interval	
<input type="checkbox"/> TV	
<input type="checkbox"/> Qualified	
<input type="checkbox"/> Dropout	
trigger on	
<input checked="" type="checkbox"/> 1	<input type="checkbox"/> 2
<input type="checkbox"/> 3	<input type="checkbox"/> 4
<input type="checkbox"/> Ext	<input type="checkbox"/> Ext10
<input type="checkbox"/> Pattern	
coupling	
<input checked="" type="checkbox"/> DC	<input type="checkbox"/> AC
<input type="checkbox"/> LFREJ	<input type="checkbox"/> HFREJ
at end of	
<input checked="" type="checkbox"/> Neg	<input type="checkbox"/> Pos
pulse	
width <	
<input type="checkbox"/> OFF	<input checked="" type="checkbox"/> On
12.5 ns	
& width >	
<input type="checkbox"/> OFF	<input checked="" type="checkbox"/> On
2.5 ns	

type

Select **GLITCH** trigger.

trigger on

Selects the source of the GLITCH trigger.

coupling

Selects the coupling of the GLITCH trigger.

at end of

Defines the test on either **positive** or **negative** pulses.

width <

Trigger if the pulse is smaller than the value defined in that field. The value can be adjusted with the menu knob associated with the field. The test can be turned on or off by pressing the menu button, and can be used in combination with the **width >** test.

Width values in the range 2.5 ns to 20 s may be entered.

& width >

Trigger if the pulse is greater than the value defined in that field. The value can be adjusted with the menu knob associated with the field. The test can be turned on or off by pressing the menu button, and can be used in combination with the **width <** test.

The two width limits are combined to select glitches within (&) a window if the width < value is greater than the width > value. Otherwise, they are combined to select glitches outside of (OR) the window.

When "Pattern" is selected in GLITCH trigger type, the instrument triggers on the logic AND of up to four sources (up to two on 2-channel instruments). See also Pattern trigger, page 11-19.

SMART TRIGGER	
type	
GLITCH	
Interval	
TV	
Qualified	
Dropout	
trigger on	
1 2 3 4 Ext	
Ext10 Pattern	
for pattern	
Present	
Absent	
width <	
12.5 ns	
OFF On	
& width >	
2.5 ns	
OFF On	

trigger on

Select **Pattern**.

for pattern

Select pattern **Present** or **Absent**.

width <

Trigger if the pattern is present – or absent – for less than the time value defined in that field. The value can be adjusted with the menu knob associated with the field. The test can be commuted to **for >** by pressing the menu button.

& width >

Trigger if the pattern is present – or absent – for more than the time value defined in that field. The value can be adjusted with the menu knob associated with the field. The test can be commuted to **for <** by pressing the menu button.

Interval Trigger

Similar to GLITCH trigger except that the test is performed over an interval width rather than over a pulse width. See figure below.

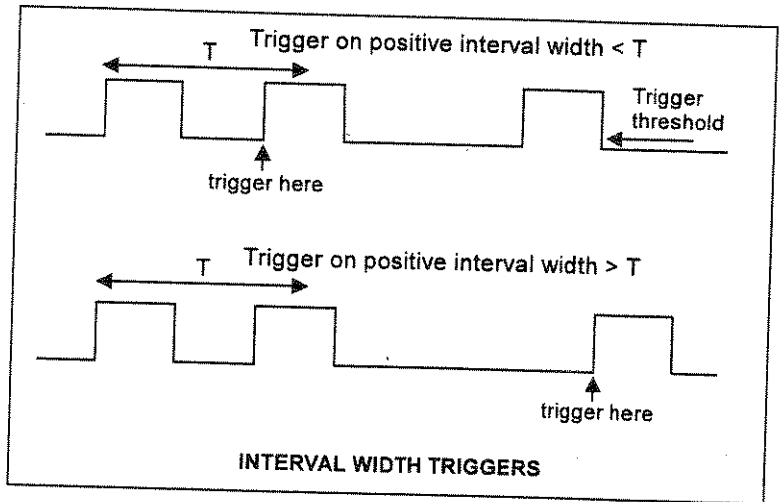

This trigger generates an event if the interval between two similar transitions of the trigger signal satisfies the desired limits. It is similar to the GLITCH trigger except that the lower time limit is 10 ns.

Missing bits in long data streams are easily triggered on using the interval-width triggering facility. For ranging applications, interval trigger may be used to ignore unwanted signal reflections.

SMART TRIGGER	
type	
GLITCH	Interval
TV	Qualified
Dropout	
trigger on	
1	2 3 4 Ext
Ext10	Pattern
coupling 1	
DC	AC
LFREJ	HFREJ
between	
Pos	Neg
edges	
interval <	
42.5 ns	
OFF	On
OR interval >	
0.645 ms	
OFF	On

type

Select **Interval** trigger.

trigger on

Selects the source of the Interval trigger.

coupling

Selects the coupling of the Interval trigger.

between

Defines the interval between two adjacent **positive** or **negative** edges.

interval <

Trigger if the interval is smaller than the value defined in that field. The value can be adjusted with the menu knob associated with the field. The test can be turned on or off by pressing the menu button, and can be used in combination with the **interval >** test.

Interval values in the range 10 ns to 20 s may be entered.

OR interval >

Trigger if the interval is greater than the value defined in that field. The value can be adjusted with the menu knob associated with the field. The test can be turned on or off by pressing the menu button, and can be used in combination with the **interval <** test.

The two interval limits are combined to select intervals within (&) a window if the interval < value is greater than the interval > value. Otherwise, they are combined to select intervals outside of (OR) the window.

TV Trigger

The TV trigger allows stable triggering on standard or user-defined composite video signals. The oscilloscope can trigger on a specific line of a given field.

This trigger is a special form of the Edge-qualified trigger. A composite video signal on the trigger input is analyzed to provide a signal for the beginning of the chosen field (any, odd, or even) and a signal at the beginning of each line. The field signal provides the starting transition and the beginning of line pulses are counted to allow the final trigger on the chosen line. The TV trigger includes an enhanced field counting capability which can maintain the trigger on a known field relative to some initial trigger (FIELDLOCK). The field, number of fields and the field rate, interlace factor, and number of lines/picture must be specified for this feature. Standard settings exist for the most popular forms of TV signals. The TV trigger can also function in a simple any-line mode. Applications can be found wherever TV signals are present.

SMART TRIGGER	
type	
GLITCH	
Interval	
TV	
Qualified	
Dropout	
TV signal on	
1	2 3 4
Ext	Ext10
# of Fields	
1	2
4	8
TV type	
Standard	
Custom	
as	
625/50/2:1	
525/60/2:1	
trigger on	
Line	Field
315	2

type

Select TV trigger.

TV signal on

Selects the source of the TV trigger.

of fields

Defines the number of fields (up to 8).

TV type

Selects either standard or custom TV decoding.

as

When the TV type on the above field is set to standard, selects between 625/50/2:1 or 525/60/2:1 standard. When the TV type is set to custom, defines the number of lines, number of cycles, and interlacing factor for non-standard TV signals.

trigger on

Selects the line and field number the oscilloscope should trigger on.

NOTES

A. Most TV systems have more than two fields and the enhanced field-counting capability (FIELDLOCK) allows the oscilloscope to trigger consistently on a chosen line within a chosen field of the signal. It should be noted that the field numbering system is relative in that the oscilloscope cannot distinguish between lines 1, 3, 5, and 7 (or 2, 4, 6, and 8) in an absolute way.

B. For each of the characteristics the following remarks apply:

1) 625/50/2:1 (European style PAL and SECAM systems)

This setting should be used for most of the standard 50 field/s signals. The lines may be selected in the range 1 to 626 where line 626 is identical to line 1.

Number of fields = 8 should be very useful for color PAL signals. Number of fields = 4 is appropriate for SECAM signals.

2) 525/60/2:1 (American style NTSC systems)

This setting should be used for standard 60 field/s NTSC signals. The lines are selectable in the range 1 to 1051, where line 1051 is identical to line 1.

Number of fields = 4 should be very useful for American-style NTSC systems.

3) ?/50?, ?/60?

In order to allow maximum flexibility, no line-counting convention is used. The line count should be thought of as a line-synchronizing pulse count, and it includes the transitions of the equalizing pulses. For certain extreme cases of TV signals, the field transition recognition will no longer work. In this case, only the "any line" mode will be available.

C. The enhanced field-counting capability cannot be used for RIS acquisitions.

D. Composite video signals must have negative-going synch to be decoded correctly.

Qualified Trigger

In this mode a transition of one signal above or below a given level, the validation, serves as an enabling condition to a second signal which is the source of the trigger. The trigger can occur either immediately after the validation, within a time limit after the validation, or after a predetermined time delay or count of potential trigger events. It is important to note that the time delay or trigger count is restarted at every validation. For the State-qualified mode of this trigger, the amplitude of the first signal must remain in the desired state until the trigger occurs. In the Edge-qualified mode, the validation is sufficient and there is no additional requirement placed on the first signal.

Typical applications can be found wherever time violations may occur, for example in micro-processor debugging or telecommunications.

State-Qualified Trigger

In **State** mode, the qualifier signal is valid when it goes and stays above (or below) a defined threshold. A trigger is accepted – while the qualifier signal is valid – before or after a given time or after a given number of trigger events. When the qualifier signal ceases to be valid, the time- and event-counters are reset.

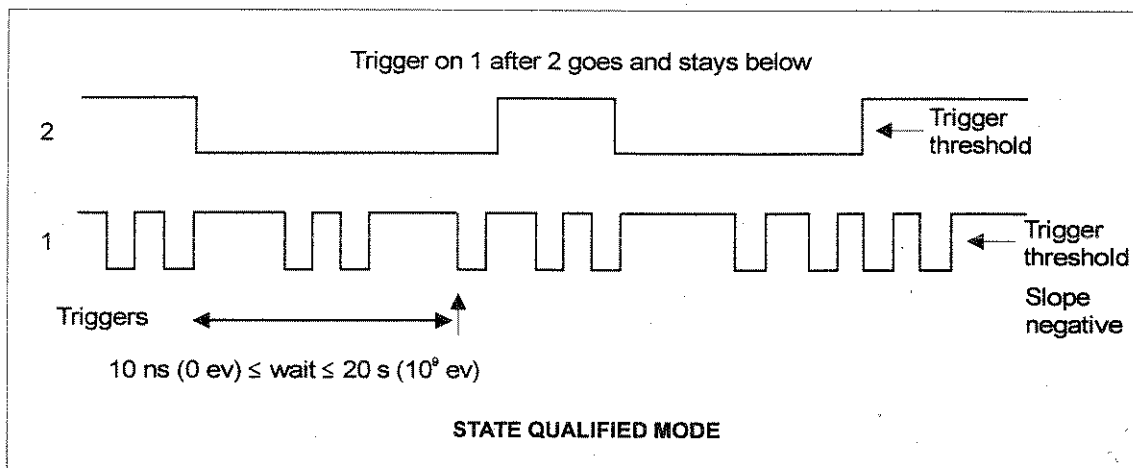

TIMEBASE + TRIGGER

SMART TRIGGER

type
Interval
TV
Qualified
Dropout
Pattern

by
Edge **State**
(qualifier)

trigger on
1 2 3 4
Ext Ext10

only after
1 **2** 3 4 Ext
Ext10 Pattern

goes & stays
Above Below
1.80 V

wait
60 ns
OFF T< **T>** Evs

type

Select **Qualified** trigger.

by

Select **State**.

trigger on

Selects the trigger source. The other conditions for this source can be set up using an Edge trigger.

only after

Selects the qualifier source. The other conditions for this source can be set up using an Edge trigger.

goes & stays

The rotary knob adjusts the qualifier threshold and the pushbutton determines whether the qualifier signal is valid above or below that threshold. When "Pattern" is selected as the qualifier source, this field determines whether the pattern should be "present" or "absent". See also Pattern trigger, page 11-19.

wait/within

Specifies the time limit (T<) for accepting the trigger event. Alternatively, it specifies how much time (T>) or how many trigger events (Evs) should be allowed before the acquisition is taken on the next trigger event. The qualifier signal must remain valid until the final trigger has been received.

The time value can be chosen in the range 10 ns – 20 s.

The trigger event count can be chosen in the range 1 – 10⁹.

Edge-Qualified Trigger

In **Edge** mode, the qualifier signal is valid as soon as it has gone above (or below) a defined threshold (valid transition). A trigger is accepted within a time or after a given time or number of trigger events. However, as soon as a new valid transition occurs, the time- and event-counters are reset.

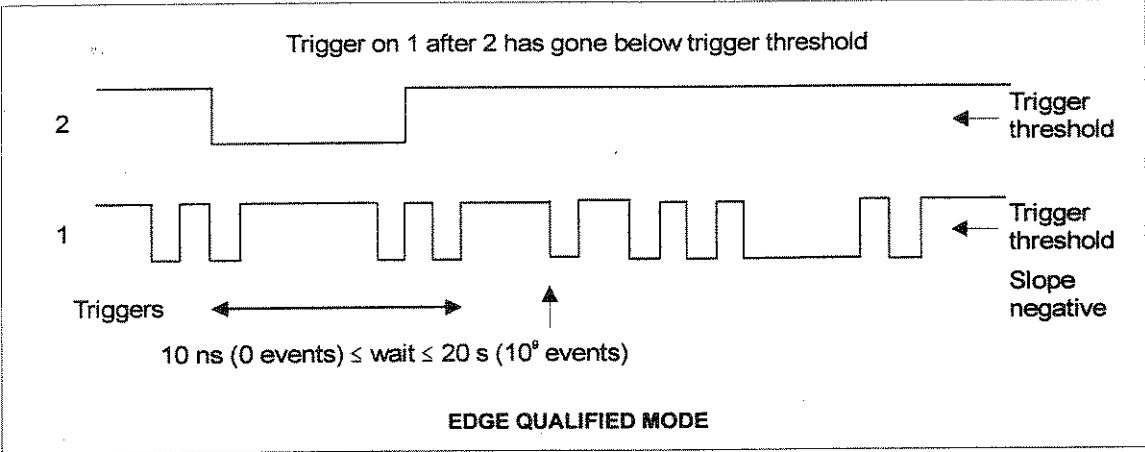

TIMEBASE + TRIGGER

SMART TRIGGER

type
Interval
TV
Qualified
Dropout
Pattern

by
Edge State
(qualifier)

trigger on
1 2 3 4
Ext **Ext10**

after
1 2 3 4 Ext
Ext10 Pattern

has gone
Above Below
0.260 V

within
130 ns
OFF T> Evs

type

Select **Qualified** trigger.

by

Select **Edge**.

trigger on

Selects the trigger source. The other conditions for this source can be set up using an Edge trigger.

after

Selects the qualifier source. The other conditions for this source can be set up using an Edge trigger.

has gone

Adjusts the qualifier threshold and determines whether the qualifier signal is valid once it *has gone* above or below that threshold. When "Pattern" is selected as the qualifier source, this field determines whether the pattern should be "present" or "absent". See also Pattern trigger, page 11-19.

wait/within

Specifies the time limit (T<) for accepting the trigger event. Alternatively, it specifies the delay in time (T>) or number of trigger events (Evs) after a valid transition has occurred. A trigger can only be accepted after this delay

Note: Any subsequent qualifier event restarts this count.

The time value can be chosen in the range 10 ns – 20 s.

The trigger event count can be chosen in the range 1 – 10⁹.

Dropout Trigger

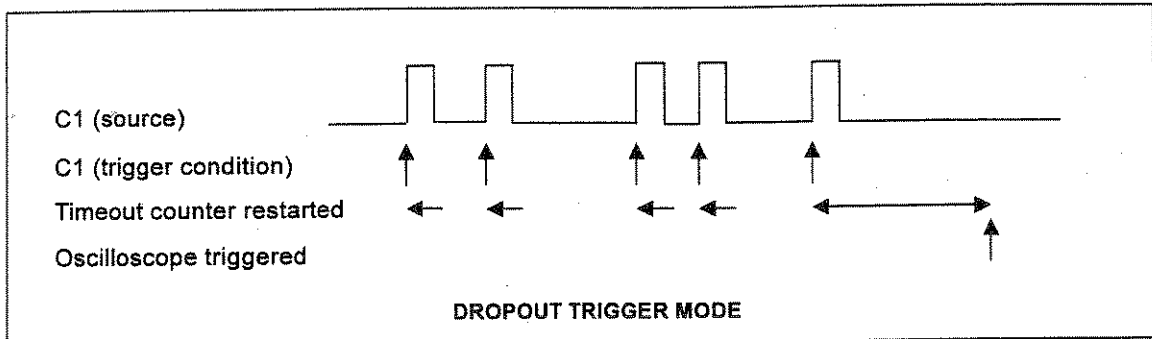

In this mode, a trigger is generated if edge-like signal transitions cease on the trigger source for the timeout value selected. The trigger event is generated at the end of the timeout period following the "last" trigger source transition.

A typical application is to look at the last "normal" interval of a signal that has disappeared completely. This is an essentially single-shot application, usually with a pre-trigger delay. A RIS acquisition does not make any sense since the timing of the trigger timeout is not sufficiently well correlated with the input channel signals.

SMART TRIGGER

type

Interval
TV
Qualified
Dropout
Pattern

Trigger after
timeout, if
NO edge

occurs on

1 2 3 4
Ext **Ext10**

with slope

Positive
Negative

within

1.64 μ s
(timeout)

of previous
edge

type

Select **Dropout** trigger.

trigger after timeout, if NO edge occurs on

Selects the Dropout trigger source.

with slope

Defines whether the measurement has to be made starting on a **Positive** or **Negative** slope of the trigger signal.

within... of previous edge

Defines the time-out value in the range 25 ns – 20 s.

Pattern Trigger

A pattern trigger is defined as a logical AND combination of the states of Channel 1, Channel 2, Channel 3, Channel 4 and EXT. The states are defined as being either low (L) or high (H) or don't care (X) with respect to the individually defined trigger thresholds. Furthermore, the user decides whether the oscilloscope should trigger at the beginning of the defined pattern or at the end, i.e. when the pattern is "entered" or "exited".

The pattern trigger will be appreciated every time complex logic has to be tested. Examples are: computer or microprocessor debugging; High Energy Physics where a physical event is identified by several events occurring simultaneously; and debugging of data transmission buses in telecommunications.

When set to pattern trigger, the oscilloscope always checks the logic AND of the defined input logic states. However, with the help of de Morgan's laws, the pattern becomes much more general. To demonstrate this, consider an example which is of particular importance, that is a *bi-level* or *window* trigger.

Bi-level trigger means that the user is expecting a single-shot signal where the amplitude will go outside a known range in either direction.

To set up a bi-level trigger the signal should be connected to two inputs, Channel 1 and Channel 2 (or any other pair of triggerable inputs). For example, the threshold of Channel 1 should be set to +100 mV and the threshold of Channel 2 to -200 mV. The required bi-level trigger will occur if the oscilloscope triggers on Channel 1 for any pulse greater than +100 mV or on Channel 2 for any pulse more negative than -200 mV. For improved precision, the gains of the two channels should be at the same setting.

In Boolean notation we can write:

$$\text{Trigger} = \text{CH1} + \overline{\text{CH2}}$$

i.e. trigger when entering the pattern:

$$\text{CH1} = \text{high OR CH2} = \text{low}$$

By de Morgan's laws this is equivalent to:

$$\text{Trigger} = \overline{\overline{\text{CH1}} \cdot \text{CH2}}$$

i.e. trigger when exiting the pattern:

$$\text{CH1} = \text{low AND CH2} = \text{high}$$

This configuration can be programmed easily.

The possibility of setting the threshold individually for each channel extends this method to a more general window trigger where, in order to have a trigger it is required that the input pulse amplitude lies within or outside a given arbitrary window.

The pattern trigger has been designed to let the user choose the trigger point. By choosing LHX entering, the trigger will be given at the moment that the pattern LHX becomes true.

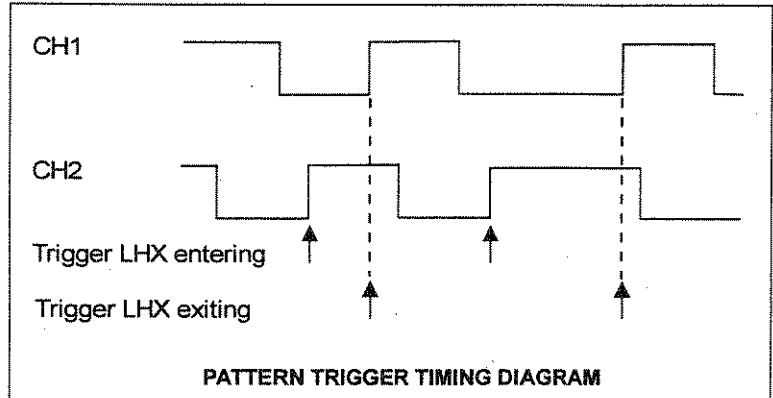

SMART TRIGGER	
type	
Interval	
TV	
Qualified	
Dropout	
Pattern	
trigger on	
Exiting	
Entering	
Pattern with	
1 L 2 L 3 H	
4 H Ext L	
coupling 1	
DC AC	
LFREJ HFREJ	
level	
0.260 V	
L H X	
holdoff	
1.61 μ s	
OFF Time Evts	

type

Select **Pattern** trigger.

trigger on

Select **Entering** if the oscilloscope ought to trigger when the pattern starts to be "true", or **Exiting** if it ought to trigger when the pattern stops being "true".

Pattern with

Select the channel to be modified, then change settings in lower menu boxes.

coupling

Select coupling desired.

Note: HF coupling is not available for Pattern trigger.

level

Use the knob to adjust the level, and the button to choose between L (Low), H (High), or X (Don't care).

holdoff

Holdoff disables the oscilloscope's trigger circuit for a definable period of time or number of events *after* a trigger event occurs.

By pressing the holdoff menu button, holdoff can be defined as:

- a period of time
- a number of events (an event being a change in the input signals that satisfies the trigger conditions)

The menu knob is used to vary the "holdoff" value.

Time holdoff values in the range 50 ns – 2.0 s are allowed.

Event counts in the range 1 – 10⁹ are allowed.

SMART Trigger Symbols

Trigger Symbols are used to allow immediate recognition of the current trigger conditions. Examples of SMART trigger symbols are given in the following figure. The heavier transitions show where a trigger will be generated.

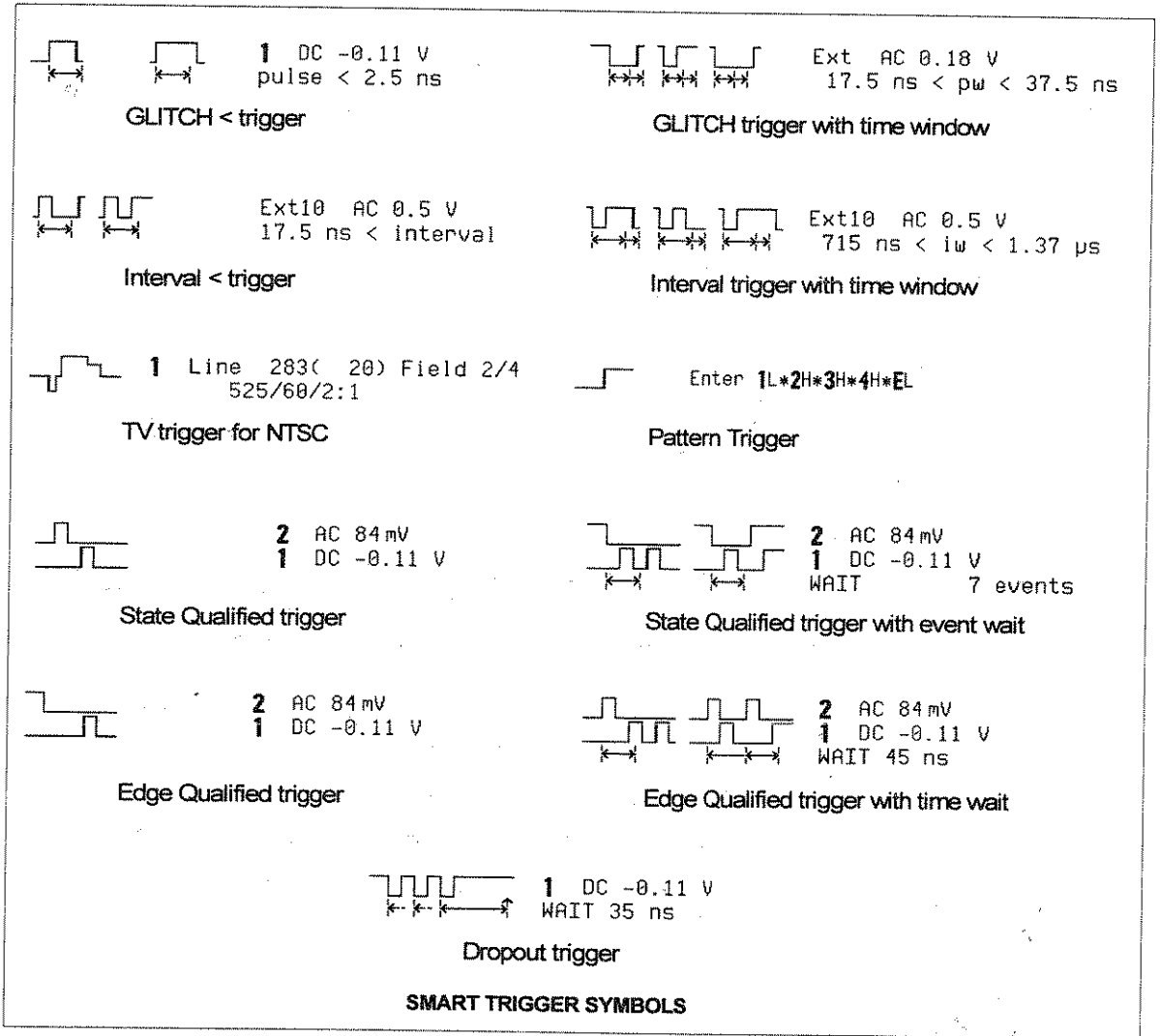

2-channel oscilloscopes

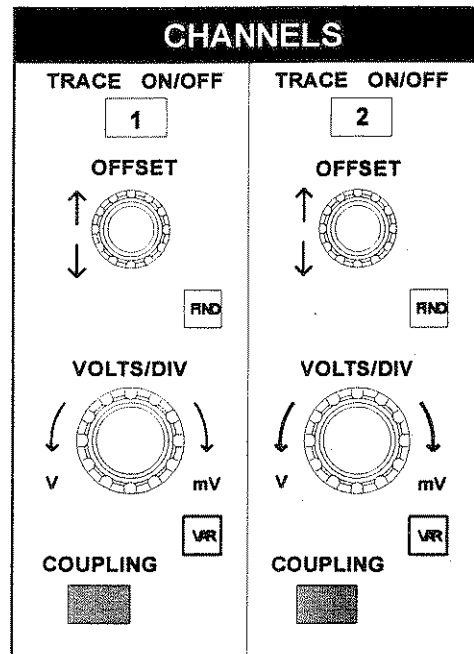
**TRACE ON/OFF**

Pressing a TRACE ON/OFF button causes the corresponding channel trace to be displayed or to be switched off.

OFFSET

This knob vertically positions the channel.

FIND

This button automatically adjusts the offset and the volts/div to match the input signal in the channel.

VOLTS/DIV

Selects the vertical sensitivity factor in a 1-2-5 sequence, or continuously (see VAR). The effect of gain changes on the acquisition offset can be chosen as described in the SPECIAL MODES menu (Chapter 19).

VAR

This button allows the user to choose whether the VOLTS/DIV knob modifies the vertical sensitivity in a continuous manner or in discrete 1-2-5 steps.

CHANNELS

The format of the vertical sensitivity in the acquisition summary field (bottom left of the screen) shows whether the VOLTS/DIV knob is operating in the "continuous" or "stepping" mode.

COUPLING

This button calls up the COUPLING menu described in Chapter 13.

4-channel oscilloscopes

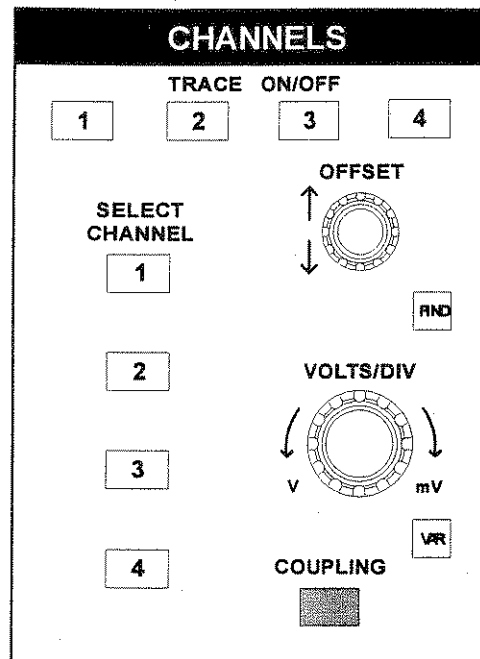
**TRACE ON/OFF**

Pressing a TRACE ON/OFF button causes the corresponding channel trace (1, 2, 3 or 4) to be displayed or to be switched off. The OFFSET and VOLTS/DIV controls will then be attributed to this channel, which will be referred to as the active channel.

SELECT CHANNEL

The SELECT CHANNEL buttons are used to activate the corresponding channel (i.e. all the vertical controls will be attributed to it). This control is independent of whether the channel is displayed or not. The selected channel is highlighted in the acquisition summary field.

OFFSET

This knob vertically positions the active channel.

FIND

This button automatically adjusts the offset and the volts/div to match the input signal in the active channel.

CHANNELS

VOLTS/DIV

Selects the vertical sensitivity factor in a 1-2-5 sequence, or continuously (see VAR). The effect of gain changes on the acquisition offset can be chosen as described in the SPECIAL MODES menu (Chapter 19).

VAR

This button allows the user to select whether the VOLTS/DIV knob modifies the vertical sensitivity in a continuous manner or in discrete 1-2-5 steps.

The format of the vertical sensitivity in the acquisition summary field (bottom left of the screen) shows whether the VOLTS/DIV knob is operating in the "continuous" or "stepping" mode.

COUPLING

This button calls up the COUPLING menu described in Chapter 13.

COUPLING MENU

CHANNEL 1	
Coupling	
DC50Ω	
Grounded	
DC1MΩ	
Grounded	
AC1MΩ	
V/div Offset	
NORMAL	
ECL	TTL
Global BWL	
OFF	On
(30 MHz)	
Probe Atten	
x2	
x5	
x10	
x20	
x25	

The Coupling menu is used to select:

- The coupling and grounding of each input channel
- ECL or TTL gain, offset and coupling preset for the channel shown
- The bandwidth limiter for all of the channels
- The probe attenuation of each input channel

Note: On 4-channel models the SELECT CHANNEL buttons on the front panel allow the selection of the channel number in the COUPLING menu. On 2-channel models, a dedicated COUPLING menu button is available for each channel.

Coupling

Selects the coupling of the input channel. If an OVERLOAD condition is detected on a channel, the instrument will automatically set this channel to the grounded state. The button will then show OVERLOAD.

V/div Offset

If NORMAL is highlighted, pushing the button once sets the offset, Volts/div, and input coupling to properly display ECL signals. Pushing the button a second time gives the settings for TTL signals. Pushing the button once more returns the settings to those used at the last manual setup of the channel.

Global BWL

Sets the bandwidth limit OFF or ON.)

The bandwidth can be reduced from 400 MHz to 30 MHz (-3dB). Bandwidth limiting may be useful in reducing signal and system noise or preventing high-frequency aliasing. For example, bandwidth limiting reduces any high-frequency signals that may cause aliasing in single-shot applications.

Note: This command is global and affects all the input channels.

Probe Atten

Sets the probe attenuation factor related to the input channel.

CHANNELS

ProBus SYSTEM

The ProBus™ system provides a complete measurement solution from probe tip to oscilloscope display, automatically sensing the probe attenuation. Vertical gain, offset and coupling are all automatically handled via the usual front-panel controls so that the probing system is totally integrated to the instrument – and transparent to the operator. In addition, each probe has an offset and gain correction table that is automatically read by ProBus and taken into account in the oscilloscope.

This menu shows the settings available for AP020 ×10 active probe.

CHANNEL 1

Coupling

DC1MΩ
Grounded
AC1MΩ

V/div Offset

NORMAL
ECL TTL

Global BWL

OFF On
(30 MHz)

Probe sensed
(AP020)
x10

MORE ON COUPLING

In the AC position, signals are coupled capacitively, thus blocking the input signal's DC component and limiting the signal frequencies below 10 Hz.

In the DC position, all signal frequency components are allowed to pass through, and 1 M Ω or 50 Ω may be chosen as the input impedance. It should be noted that with 1 M Ω input impedance the bandwidth is limited to approximately 250 MHz.

The maximum dissipation into 50 Ω is 0.5 W and inputs will automatically be disconnected whenever this occurs. An indication of the overload can be found in the Acquisition Summary Field and in this menu. The overload condition is reset by removing the signal from the input and selecting the 50 Ω input impedance again.

PROBES

Model PP002 passive probes are supplied with the oscilloscope. These probes have 10 M Ω input impedance and 16 pF capacitance. The system bandwidth with these probes is DC to 250 MHz (typical) in 1 M Ω DC coupling, and >10 Hz to 250 MHz in AC coupling.

To calibrate the PP002 probe, connect it to one of the input channels' BNC connectors. Connect the probe's grounding alligator clip to the CAL BNC ground and touch the tip to the inner conductor of the CAL BNC. The CAL signal is a 1 kHz square wave, 1 V p-p.

Set the channel coupling to DC 1 M Ω , turn the trace ON and push AUTO SETUP to set up the oscilloscope. If over- or undershoot of the displayed signal occurs, the probe can be adjusted by inserting the small screwdriver, supplied with the probe package, into the trimmer on the probe's barrel and turning it clockwise or counterclockwise to achieve the optimal square-wave contour.

A wide range of processing functions can be performed on acquired waveforms. These capabilities are accessed through the ZOOM + MATH controls on the front panel.

Four (processed) traces, A, B, C, and D are available for either zooming alone or for waveform mathematics.

ZOOM

Any trace, A, B, C or D, can be set up to zoom any of the acquired traces C1, C2 (C3, C4), any of the reference memories M1 – M4 (see Chapter 20 on storing waveforms), or any of the other traces A, B, C or D (but not itself). The Displayed Trace field will show the source of the ZOOM. The four rotary knobs of this front-panel section are used to manipulate the horizontal and vertical positions and the horizontal and vertical expansion factors of the zoomed trace. When several traces are displayed, the controls must be assigned to the desired trace with the SELECT A B C D button, since only one trace can be modified at a time.

Precise Timing Measurements With Zooming

Even on the models with 50k points per channel, the horizontal expansion factor can be as large as 1000, greatly improving the time resolution on the viewed trace. It is possible to have several traces zoom onto the same waveform for precise timing measurements.

As an example, consider a waveform where the time interval between two signal transitions that are about 500 μs apart must be measured accurately. This waveform should be acquired with a 0.1 ms/div timebase so that the transitions appear on the screen about 5 horizontal divisions apart. Trace A can now be set up to zoom onto the first transition of the signal, while trace B is set up to zoom onto the second transition.

In an instrument with 20000 points per channel, the traces can be expanded to as much as 0.1 $\mu\text{s}/\text{div}$, i.e. a factor 1000. By applying the "relative horizontal" cursors (see Chapter 22) the 500 μs time interval can be measured with a resolution of better than 5 ns. Thus, the combination of long memory with zooming allows time interval measurements with great accuracy.

Multi-Zoom

It is sometimes convenient to be able to move the zoomed (intensified) region along two or more different traces, or two or more regions of the same trace, simultaneously. When the Multi-Zoom feature is turned on in the MATH SETUP menu, the horizontal zoom and position controls apply simultaneously to all displayed traces A,

B, C and D, allowing a convenient simultaneous viewing of similar sections of different traces. The vertical controls still act individually on the traces, and can be switched from one trace to another with the SELECT A B C D button. The boxes around the trace titles in the Displayed Trace Field show whether the Multi-Zoom is on or off.

Viewing Reference Memories

The reference memories M1 – M4 cannot be displayed directly. They must be viewed through one of the traces A, B, C or D, and the menu MATH SETUP is used to define the trace as a zoom on the desired reference memory. A shortcut is available in the menu RECALL WAVEFORM (Chapter 21), in which it is possible to "recall" a reference waveform into one of the traces A, B, C or D. Whenever such a "recall" is executed, the destination trace is redefined as a zoom of the reference memory and the trace display is turned on. The previous definition of the destination trace is lost.

WAVEFORM MATHEMATICS

Any trace A, B, C or D can be set up as a mathematical function. Waveform negation, identity, addition, subtraction, multiplication and division, as well as summed averaging of up to 1000 waveforms and the $(\sin x)/x$ interpolation function, are standard. The waveform processing options WP01 offer a wide range of additional possibilities:

- continuous averaging
- summed averaging of up to 1,000,000 waveforms
- enhanced resolution by up to 3 bits with filtering
- extrema, i.e. envelope of many waveforms
- mathematical functions, such as integral, derivative, logarithm, exponential, square, and square root
- Fast Fourier Transform (option WP02), including FFT averaging

Waveform mathematics can be applied to any channel C1, C2 (C3, C4) or any reference memory M1 – M4. Also, they can be applied to the traces A, B, C or D so that several computations can be executed in sequence. For example, trace A can be set up as the difference between C1 and C2; then, trace B can be defined as the average of A; finally, trace C can be the integral of B. Thus, trace C displays the integral of the averaged difference between channels 1 and 2.

In order to avoid slowing the instrument down for unwanted computations, a mathematical function is only computed when its display is turned on. However, in the example above, it would be sufficient to

display trace C only; the instrument knows that it must compute A and B as intermediate steps to C.

The Displayed Trace field will show a processing title for each trace on display. If the title is missing, it is an indication that the processing desired cannot be done and the contents of the trace have been left unchanged.

Zoom of Math Functions

When a trace A, B, C or D is defined as a mathematical function (rather than a Zoom only), the zoom controls are still operative. Thus, it is not necessary to define another trace as a zoom of this function. In order to view the entire mathematical function, cancel any expansion or position change by pressing the button RESET.

Speed-up of Waveform Mathematics

Waveform processing can take an appreciable execution time when operating on many data points. The time, however, can be reduced by limiting the number of data points which are used in the computation. The instrument then executes the waveform processing function on the entire waveform by taking every Nth point, where N depends on the timebase and the desired maximum number of points. The first point of such a reduced record is always the data value at the left-hand edge of the screen.

What happens when channels are combined?

"Zoom & Math" traces A, B, C, D and reference memories M1, M2, M3, M4 will use the instrument's system memory, which is dynamically allocated to each trace as necessary.

Since more acquisition memory — up to 4M on 2-channel L models and up to 8M on 4-channel L models — can be achieved by combining two or four channels, one single 8M trace can "eat up" all of the reference memory capacity in the instrument, or all of its "Zoom & Math" trace capacity. When this is the case, a warning message prevents accidental storing of a new trace to a reference memory already in use.

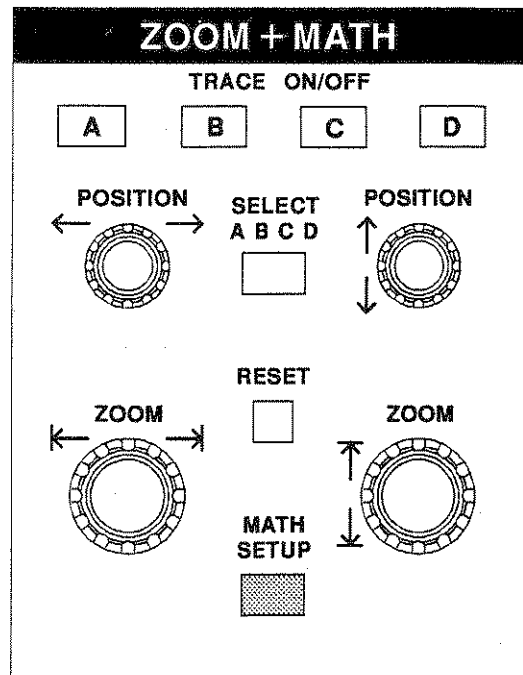
**TRACE ON/OFF**

Pressing a TRACE ON/OFF button causes the corresponding trace (A, B, C or D) to be displayed. The POSITION and ZOOM knobs together with the RESET button will then be attributed to this trace, which will be referred to as the active trace.

SELECT TRACE

If more than one trace is displayed, the SELECT ABCD button causes the next trace (in the ABCD sequence) to become active.

⇔ POSITION

Horizontally repositions an expanded trace. If the source of the expanded waveform is displayed, it will show an intensified region corresponding to the area of expansion.

⇕ POSITION

Vertically repositions the active trace.

⇔ ZOOM

Horizontally expands/contracts the active trace. If the source of the expanded trace is also displayed, it will show an intensified region corresponding to the area of expansion.

⇕ ZOOM

Vertically expands/contracts the active trace. The ⇕ position is adjusted according to the selection made in the SPECIAL MODES menu (Chapter 19).

RESET

This button resets any previously adjusted ⇔ POSITION, ⇕ POSITION, ⇔ ZOOM or ⇕ ZOOM to the initial values of the source trace.

MATH SETUP

This button calls up the MATH SETUP menu described in Chapter 16. In addition to the definition of the traces A, B, C, D, this menu also controls the multi-zoom mode and the choice of sequence segment displayed by an expand.

MATH SETUP MENU

The Math Setup menu is used to select:

- Zoom features: vertical, horizontal, multi-zoom, etc...
- Math features: Arithmetic, Average, Enhanced Resolution, Extrema, Fast Fourier Transform (FFT), and various functions such as integral, exponential, square root...
- A sequence segment to be displayed (see Chapter 8 for a description of Sequence mode).

HOW TO USE MATH

Four traces (A,B,C,D) are provided for "Math" usage. They can be configured to execute any Zoom or Math function, and they can be chained. For instance:

- Trace A can be configured to be an averaging of Channel 1
- Trace B can be a Fourier Transform (FFT) of A
- Trace C can be a Zoom of B

All these traces can be seen SIMULTANEOUSLY on the screen by pressing the required TRACE ON/OFF buttons. Also, any function can be zoomed directly.

STANDARD AND OPTIONAL PROCESSING PACKAGES

The standard Waveform Processing features of the instrument include Summed Averaging up to 1000 sweeps and Arithmetic operations (Add, Subtract, Multiply, Divide, Negate, Identity), and the $(\sin x)/x$ interpolation function.

The WP01 optional Waveform Processing firmware adds the following functionalities:

- Summed Averaging up to 1 million sweeps, Continuous Averaging up to 1024 sweeps, Reciprocate, Rescale, Absolute Value, Derivative, Integral, Logarithm (e), Logarithm (10), Exponential (e), Exponential (10), Square, Square Root.
- Enhanced Resolution: Digital filtering allows 0.5- to 3-bit vertical resolution improvement.

The WP02 optional Waveform Processing firmware adds frequency domain analysis (FFT and FFT Power Averaging), as well as Rescale in both time and frequency domains.

ZOOM + MATH
REDEFINE A A=1
REDEFINE B B=2
REDEFINE C C=1
REDEFINE D D=2
Multi-Zoom OFF On
for Math use max points 250000

REDEFINE

Selects the trace to be redefined in the Setup menu. The various Setup menus are described in the rest of this chapter.

Multi-Zoom

When Multi-Zoom is ON, all the "Zoom" traces are simultaneously controlled by the POSITION and ZOOM knobs.

When Multi-Zoom is switched OFF, only the active trace (selected by pressing the SELECT ABCD button) is controlled by the POSITION and ZOOM buttons.

Selected

When a trace A...D that contains a Sequence mode waveform is selected, this box appears in the menu. It is used to select either a specific segment to be displayed in the trace or all the segments at once. Pressing the menu button toggles between a single **Segment** and **All Segments**. When a single segment is selected, the associated rotary knob can be used to step through the segments.

for Math use max points...

Selects the maximum number of points for all Math operations. Selecting a low number increases computation speed.

SETUP MENU FOR ZOOM

SETUP OF A

use Math?
 No Yes

Trace A is
ZOOM of

<input checked="" type="checkbox"/>	2	3	4	B	C	D
	M1	M2	M3	M4		

use Math?

Toggles between No (Zoom only) and Yes (Math + Zoom) setup.

Trace ... is ZOOM of

Selects the source trace on which the zoom will be applied.

SETUP MENU FOR ARITHMETIC

This menu allows addition, subtraction, multiplication and division. The two operands and the operator may be chosen in the three lower fields.

The menu illustrated on this page shows a setup of trace A as the sum of Channel 1 and Channel 2.

SETUP OF A
use Math? No Yes
Math Type Arithmetic Average Enh. Res Extrema FFT
Sum Difference Product Ratio
2 3 4 B C D M1 M2 M3 M4
plus 1 3 4 B C D M1 M2 M3 M4

use Math?

Select Yes.

Math Type

Select Arithmetic.

**SETUP MENU FOR
AVERAGE**

This menu allows summed (linear) averaging or continuous (exponential) averaging.

Summed averaging consists of the repeated addition, with equal weight, of successive source waveform records. If a stable trigger is available, the resulting average has a reduced random noise component, compared with a single-shot record. Whenever the maximum number of sweeps is reached, the averaging process stops. The process may be interrupted by switching the trigger mode from NORM to STOP or by turning the function trace OFF. Averaging will continue when these actions are reversed.

The accumulated average may be reset by either pushing the CLEAR SWEEPS button or by changing an acquisition parameter, such as input gain, offset or coupling, trigger condition, timebase or bandwidth limit. The number of currently averaged waveforms (of the function or of its expansion) is displayed in the Displayed Trace field.

Whenever the maximum number of sweeps is reached, a larger number of sweeps may be accumulated by simply changing the maximum number of sweeps in the setup menu. In this case care must be taken to leave the other parameters unchanged, otherwise a new averaging calculation is started.

When summed averaging is turned on, the display is updated at a reduced rate (about once every 1.5 s), to increase the averaging speed (points per second and events per second).

Summed averaging can be applied to sequence waveforms to give the average of the segments. It can also be applied to an expansion showing a segment of a sequence, to give the average waveform for that segment over many sequence acquisitions.

Continuous averaging (also called exponential averaging) consists of the repeated addition, with unequal weight, of successive source waveforms. The technique is particularly useful for reducing noise on signals that drift very slowly in time or amplitude. However, the statistics of a continuous average tend to be worse than those from a summed average on the same number of sweeps, since the most recently acquired waveform has more weight than all previously acquired ones. Therefore, the continuous average is dominated by the statistical fluctuations of the most recently acquired waveforms.

The weight of "old" waveforms in the continuous average gradually tends to zero (following an exponential rule) at a rate that decreases as the weight increases.

The menu below shows a setup of trace A as a Summed Average – over 1000 sweeps – of Channel 1.

SETUP OF A

use Math?
No **Yes**

Math Type
Arithmetic
Average
Enh. Res
Extrema
FFT

Avg Type
Summed
Continuous

for
1000
(sweeps)

of
1 2 3 4 B C D
M1 M2 M3 M4

use Math?

Select **Yes**.

Math Type

Select **Average**.

Avg Type

Selects between **Summed** and **Continuous Average**.

for... / weight

In Summed Averaging mode, this field is used to define the number of sweeps desired for the operation. In Continuous Averaging mode, this field is used to define the weight (similar to the number of sweeps) desired for the operation.

In other words, in summed averaging, "for n sweeps" means the *first* n sweeps will be taken into account. In continuous averaging, "weight 1 : n" means that the last sweep will be given a weight of 1 and the previous result a weight of n in calculating the new average.

of

Selects the source trace to be averaged.

SETUP MENU FOR ENHANCED RESOLUTION

This menu allows the selection of low-pass digital filters that increase the resolution of the displayed signal to the detriment of its bandwidth. Appendix B gives a detailed explanation.

Note: These digital filters work very much like analog bandwidth-limit filters. In single-shot mode, these filters, as well as the sampling speed, affect bandwidth. If high bandwidth is needed at slow time-bases, consider using averaging and repetitive sampling.

SETUP OF A use Math? No Yes
Math Type Arithmetic Average Enh. Res Extrema FFT
enhance by 1 bit 1.5 bits 2 bits 2.5 bits 3 bits
<input type="checkbox"/> 2 <input type="checkbox"/> 3 <input type="checkbox"/> 4 <input type="checkbox"/> B <input type="checkbox"/> C <input type="checkbox"/> D <input type="checkbox"/> M1 <input type="checkbox"/> M2 <input type="checkbox"/> M3 <input type="checkbox"/> M4

use Math?

Select **Yes**.

Math Type

Select **Enhanced Resolution**.

enhance by

Selects the different filters which will enhance the resolution of the displayed signal from 1 to 3 bits in 0.5-bit steps. The last box on the menu allows selection of the source trace to be filtered

**SETUP MENU FOR
EXTREMA**

This menu is used to acquire the envelope of a trace over many acquisitions.

Extrema waveforms are computed by a repeated comparison of successive source waveform records with the already accumulated extrema waveform, which consists of a maxima record (roof) and a minima record (floor). Whenever a given data point of the new waveform exceeds the corresponding maximum value in the roof record, it replaces it. If the new data point is smaller than the corresponding floor value, it replaces it. Thus the maximum and the minimum envelope of all waveform records is accumulated.

Roof and **Floor** records can be displayed individually or both together.

Whenever the selected maximum number of sweeps is reached, the accumulation process stops. The process may be interrupted by switching the trigger mode from NORM to STOP or by turning the function trace OFF. Accumulation will continue when these actions are reversed. The currently accumulated extrema waveform may be reset by either pushing the CLEAR SWEEPS button or by changing an acquisition parameter, such as input gain, offset or coupling, trigger condition or the timebase or bandwidth limit. The number of currently accumulated waveforms is displayed in the Displayed Trace field of the function or of its expansion.

A larger number of sweeps may be accumulated by simply changing the maximum number of sweeps in the setup menu. In this case, care must be taken to leave the other parameters unchanged, otherwise the extrema calculation is started again.

SETUP OF **A**

use Math?
 No Yes

Math Type
 Average
 Enh.Res
 Extrema
 FFT
 FFTAVG

limits
 Envelope
 Floor Roof

for
 1000
 (sweeps)

of
 2 3 4 B C D
 M1 M2 M3 M4

use Math?

Select Yes.

Math Type

Select Extrema.

limits

Selects between **Envelope**, **Floor** and **Roof**. Floor is used to show only the lower part of the envelope, and Roof to show only the upper part of the envelope. Changing the limits does not force the analysis to start again.

for

Selects the number of sweeps desired for the operation.

of

Selects the source trace.

ZOOM + MATH

SETUP MENU FOR FFT

This menu is used to display the Fast Fourier Transform (FFT) of a signal in order to visualize it in the frequency domain. More details of Fast Fourier Transform are given in Appendix C.

SETUP OF A
use Math? No Yes
Math Type Enh. Res Extrema FFT FFTAVG Functions
FFT result Phase Power Dens Power Spect Real Real+Imag
with Hamming (window)
of 1 2 3 4 B C D M1 M2 M3 M4

use Math?

Select **Yes**.

Math Type

Select **FFT**.

FFT result

Selects the output format of the FFT: **Imaginary, Magnitude, Phase, Power Density, Power Spectrum, Real, Real + Imaginary.**

with

Selects the FFT window type: **Rectangular, Hanning, Hamming, Blackman-Harris, Flat-top.**

of

Selects the source trace.

FFT INTERRUPTION (ABORT)

During FFT computation the symbol **FFT** is displayed in the lower right-hand corner of the screen). Since the computation of FFT on long time-domain records may take a long time, it is possible to interrupt an FFT computation with any front-panel button or knob.

SETUP MENU FOR FFT AVERAGE

This menu is used to display the FFT power averaging of an FFT source trace.

Power averaging is useful for the characterization of broadband noise or of periodic signals for which a stable trigger signal is not available. Note that this type of averaging measures the total power (signal and noise) at each frequency.

Note: The source trace must be an FFT function.

SETUP OF A
use Math? No Yes
Math Type Extrema FFT FFTAVG Functions Rescale
FFT result Magnitude Power Dens Power Spect
for 1000 (sweeps)
of B C D

use Math?

Select **Yes**.

Math Type

Select **FFT AVG**.

FFT result

Selects the output format of the FFT Average: **Magnitude, Power Density, Power Spectrum**.

for

Selects the number of sweeps desired for the operation.

of

Selects the FFT source.

The FFT AVERAGE can be reset by pushing the CLEAR SWEEPS button. The number of currently accumulated waveforms is displayed in the Displayed Trace field of the function or its expansion.

**SETUP MENU FOR
FUNCTIONS**

This menu is used to display any of the following functions:

Absolute value	Log 10 (base 10)
Derivative	Negation
Exp (base e)	Reciprocal
Exp 10 (base 10)	Sinx/x
Identity	Square
Integral	Square root
Log (base e)	

Notes:

Square Root is actually computed on the absolute value of the source waveform.

For logarithmic and exponential functions the numerical value (without units) of the input waveform is used.

For the integral function the source waveform may be offset by an Additive Constant in the range -10^{16} to $+10^{16}$ times the vertical unit of the source waveform.

SETUP OF **A**

use Math?
 No **Yes**

Math Type
 FFT
 FFTAVG
Functions
 Histogram
 Rescale

Function
 Exp10
 Identity
Integral
 Log
 Log10

of
1.17 E-03
 3 digits

plus
1 2 3 4 B C D
 M1 M2 M3 M4

use Math?

Select **Yes**.

Math Type

Select **Functions**.

Function

Selects the function type.

of

Selects the signal offset. (Used to compensate for any DC offset in the signal.)

plus

Selects the source trace.

SETUP MENU FOR RESCALE

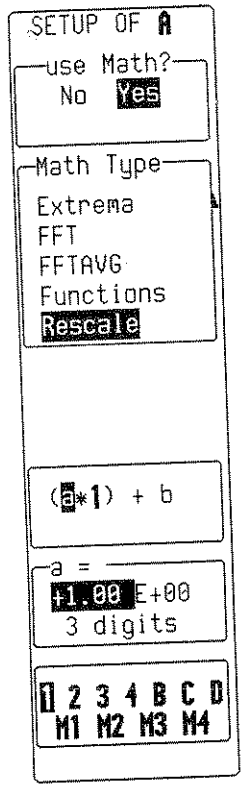

This menu is used to select a waveform and adjust the multiplication factor a and the additive constant b in:

$$(a * \text{waveform}) + b$$

Both constants can have values between -10^{15} and $+10^{15}$.

use Math?

Select Yes.

Math Type

Select Rescale.

Use the button next to (a * 1) + b to highlight either a or b.

a = (or b =)

Use this button to highlight the mantissa, the exponent, or the number of digits.

Use the knob to change the highlighted value.

The last box on the menu allows selection of the source waveform to be rescaled.

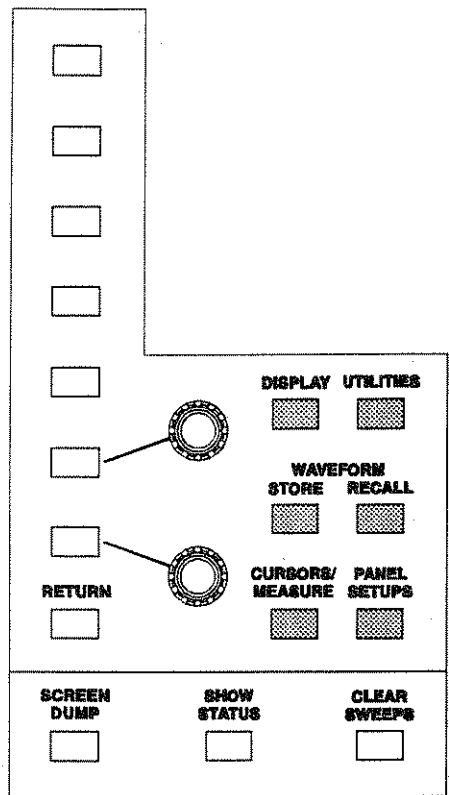

MENU BUTTONS

When a menu is activated by pressing one of the dark-grey menu-entry keys on the front panel, up to seven fields appear on the right-hand side of the display. These fields can be controlled by using one of the seven menu buttons.

The eighth (bottom) button marked RETURN is used to go back to a higher-level menu, or – when at the highest possible level – to switch the menu off.

MENU KNOBS

The two menu knobs are associated with the last two menu fields. Both the button and the adjacent knob provide control of the field. For example, the button may be used to step through a list of parameters and the knob used to set the selected parameter's value.

MENU CONTROLS

- DISPLAY** This button calls up the DISPLAY menu, described in Chapter 18, which controls grids, intensities, persistence modes, etc.
- UTILITIES** This button calls up the UTILITIES menu, described in Chapter 19, which controls printer setups, GPIB addresses, etc.
- WAVEFORM STORE** This button calls up the WAVEFORM STORE menu, described in Chapter 20, which is used to store waveforms to internal or external memory.
- WAVEFORM RECALL** This button calls up the WAVEFORM RECALL menu, described in Chapter 21, which is used to retrieve waveforms stored in internal or external memory.
- CURSORS/MEASURE** This button calls up the CURSORS/MEASURE menu, described in Chapter 22, for precise cursor and parameter measurements on traces.
- PANEL SETUPS** This button calls up the PANEL SETUPS menu, described in Chapter 23, which is used to save or recall a configuration of the instrument.
- SCREEN DUMP** Causes a print or plot of the current screen display to an on-line hardcopy device, via the oscilloscope's GPIB or RS-232-C interface ports, or to an optional Centronics port, or to optional devices such as an internal floppy, memory card or printer. All the screen illustrations included in this manual were produced using the Screen Dump function. (See Hardcopy Setup Menu on page 19-2)
- Once the SCREEN DUMP button has been pressed, *all* the displayed information will be copied. It is possible to copy the waveforms without also copying the grid, by turning the grid intensity down to 0 in the Display Setup menu.
- While a screen dump is taking place, as indicated by the PRINTING or PLOTTING message on the lower right part of the screen, it can be aborted by pressing the SCREEN DUMP button a second time. Allow some time for the buffer to empty before copying stops.
- Note: See Chapter 19, UTILITIES for HARDCOPY SETUP.*

SHOW STATUS

This button calls up the STATUS menu, described in Chapter 24, which shows summaries of the instrument's status regarding acquisition, system, etc.

CLEAR SWEEPS

Many operations require several acquisitions (referred to as sweeps), among which are averaging (see Chapter 16 for description of AVERAGE menu), persistence, and pass/fail testing. The CLEAR SWEEPS button "restarts" these operations by resetting the sweep counter(s) to zero.

**GENERAL INSTRUMENT
RESET**

To reset the instrument, simultaneously press the AUTO SETUP button, the top menu-button, and the RETURN button. The instrument will revert to its default power-up settings.

DISPLAY MENU

The Display menu is used to select:

- Standard or XY mode
- Persistence OFF or ON
- Dot Join OFF or ON
- The number of grids on screen
- The intensity adjustments for the waveforms and text
- The intensity adjustments for the grids

**STANDARD DISPLAY VS.
XY DISPLAY**

The standard display allows the presentation of source waveforms versus time (or versus frequency for FFTs).

The XY display allows the presentation of one source waveform versus another.

The XY display can be generated if the traces selected have the same time or frequency span (same T/div) and have the same horizontal unit (second or Hertz). As soon as two compatible traces are selected, the XY display is automatically generated. If incompatible traces are selected, a warning message is displayed at the top of the screen. If the two compatible traces are not matched in time, their XY diagram will still be displayed with an indication of the shifting – in time or in frequency – between the two traces. The ΔT or Δf indicator is displayed in the displayed trace field on the left of the screen.

MENU CONTROLS

PERSISTENCE DISPLAY

In Persistence Display – available in both Standard and XY mode – the oscilloscope can display points so that they accumulate on screen over many acquisitions. "Eye diagrams" and "Constellation displays" can be achieved using this display mode. The most recent sweep is displayed as a "vector" trace over the persistence display. This last feature, however, is not available in XY or in Sequence mode.

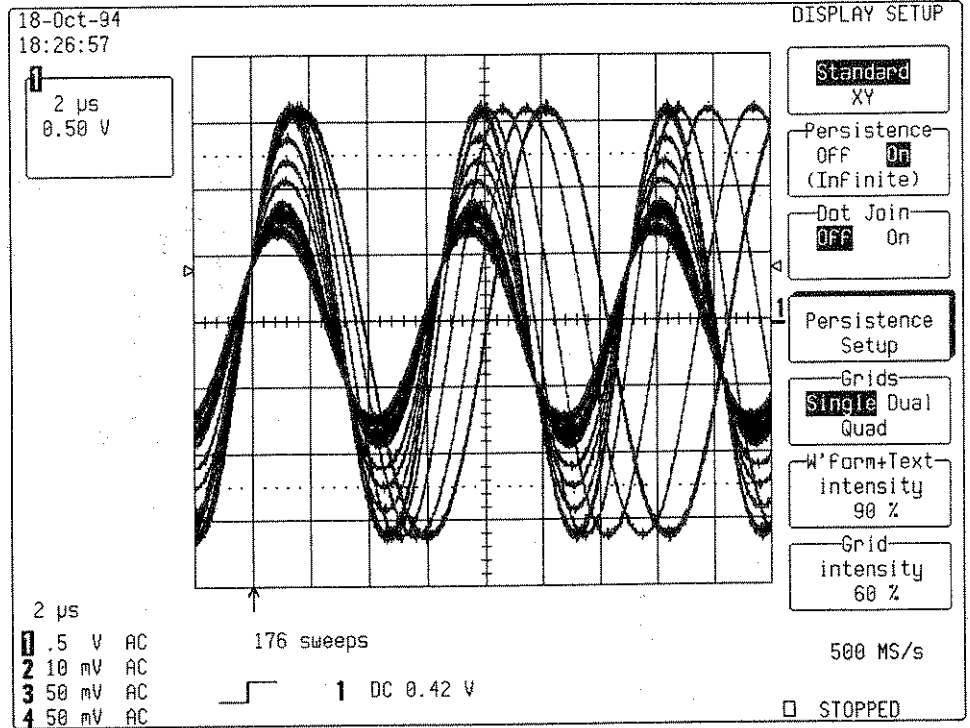

SCREEN PRESENTATION

Grid sizes and presentations depend on whether the instrument is in Standard or in XY display.

The "Parameter" display can only be chosen in Standard display with persistence OFF, by accessing the CURSORS/MEASURE menu and selecting parameters or PASS/FAIL. In "Parameter" display, only single-grid presentation is available.

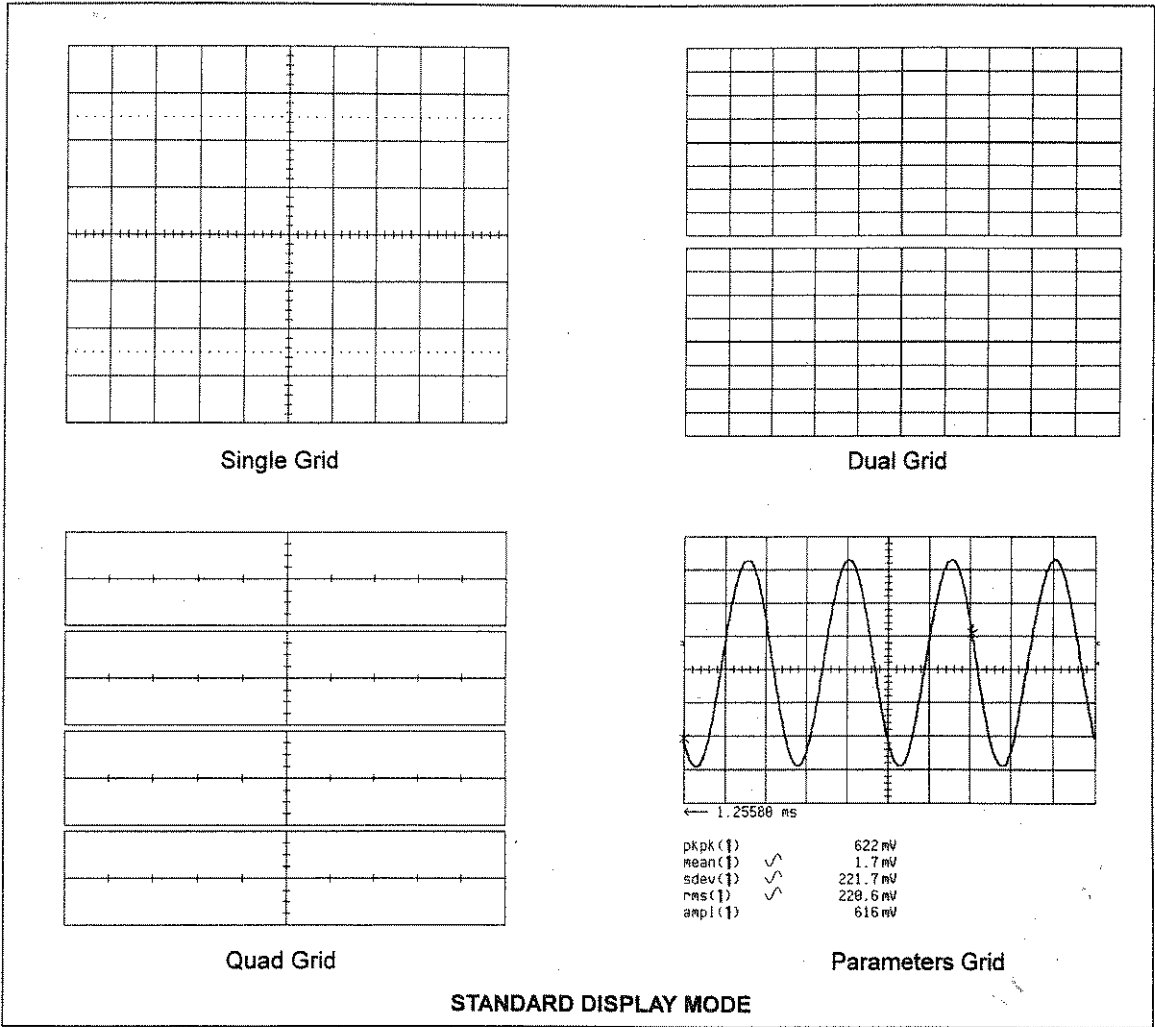

MENU CONTROLS

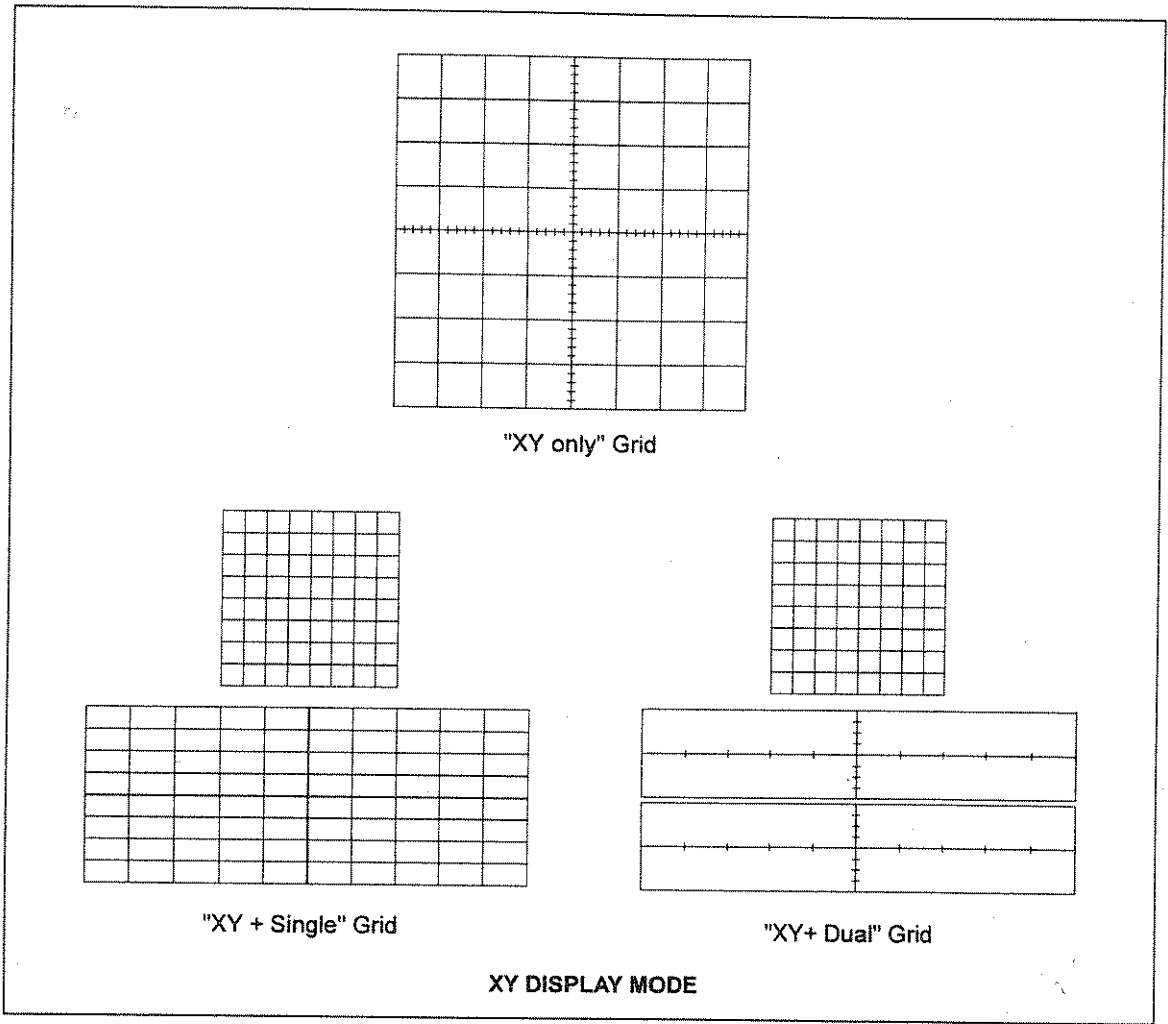

Display

STANDARD DISPLAY

DISPLAY SETUP	
Standard	Y
Persistence	OFF <input checked="" type="radio"/> On (Infinite)
Dot Join	OFF <input checked="" type="radio"/> On
Persistence Setup	
Grids	Single Dual Quad
W'form+Text intensity	90 %
Grid intensity	60 %

Persistence

Selects the persistence mode. When set to ON, can be cleared and reset by pressing the CLEAR SWEEPS button or by changing any acquisition condition, any waveform processing condition, or the number of grids.

Dot Join

When set to ON, connects the sample points with a line segment. When set to OFF, only the sample points are displayed.

Persistence Setup

Calls the persistence setup menu.

Grids

Selects the desired number of grids. If the "Parameters" or the "PASS/FAIL" mode is selected in the CURSORS/MEASURE menu, then only the single grid is available.

W'form + Text intensity

Adjusts the screen intensity for waveforms and text, using the attributed menu knob.

Grid intensity

Adjusts the screen intensity for grids, using the attributed menu knob. If the grid intensity is turned down to 0, the grids will not show on a screen dump.

XY DISPLAY

DISPLAY SETUP	
Standard	XY
Persistence	OFF On
Dot Join	OFF On
Grids	XY only
Single Dual	
W'form+Text	intensity
	90 %
Grid	intensity
	60 %

Persistence

Selects the persistence mode. When set to ON, can be cleared and reset by pressing the CLEAR SWEEPS button or by changing any acquisition condition, any waveform processing condition, or the number of grids. The number of sweeps accumulated (up to 1000000) is displayed below the grid. Persistence is not available for traces with more than 50000 points (L and M models only).

Dot Join

When set to ON, connects the sample points with a line segment. When set to OFF, only the sample points are displayed.

Grids

Selects the desired number of grids. In "XY only" mode, the XY grid occupies the maximum possible space on screen. In Single Grid, a smaller square grid is used for the XY display while the rectangular grid underneath simultaneously shows the original source waveforms. The rectangular grid can also be used in a dual grid mode by selecting Dual Grid.

W'form + Text intensity

Adjusts the screen intensity for waveforms and text; using the attributed menu knob.

Grid intensity

Adjusts the screen intensity for grids, using the attributed menu knob. If the grid intensity is turned down to 0, the grids will not show on a screen dump.

PERSISTENCE

PERSISTENCE

Persistence
All traces
Top 2

Persist for
0.5 s 1 s
2 s 5 s
10 s 20 s
Infinite

Persistence

Selects whether persistence is applied to all or to the two top traces.

Persist for

Selects the persistence duration, in seconds.

UTILITIES MENU

This section describes the Utilities menu which is used to select:

- The hardcopy settings.
- The time and date settings for the real-time clock.
- The GPIB and RS232 settings.
- The mass storage utilities (copy and format, delete files...).
- The Special Mode of operation (offset behavior, sequence time-out).
- The function of the signal at the CAL BNC connector (magnitude, frequency, shape, trigger out, pass/fail use).

UTILITIES MAIN MENU

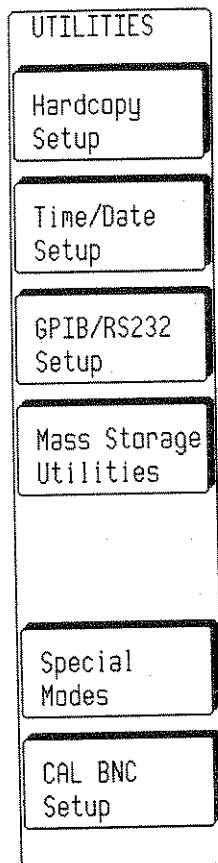
**Hardcopy Setup** (See page 19-2)

Press this button to view/change the current printer or plotter settings.

Time/Date Setup (See page 19-4)

Press this button to adjust the real-time clock displayed in the upper left corner of the screen.

GPIB/RS232 Setup (See page 19-5)

Press this button to view/change the current interface settings.

Mass Storage Utilities (See page 19-12)

Press this button to access the Mass Storage Utilities menu.

Special Modes (See page 19-20)

Press this button to access the Special Modes menu.

CAL BNC Setup (See page 19-22)

Press this button to access the CAL BNC menu. This button only appears in instruments with the CLBZ hardware option.

HARDCOPY SETUP MENU

HARDCOPY	
output to	
Card	
Disk	
GPiB	
RS232	
Centronics	
page feed	
OFF	On
plotter	
DeskJet b/w	
HP 7470	
HP 7550	
TIFF	
TIFF compr.	
plot size	
A5 (8.5"/5.5")	
A4 (11"/8.5")	
pen number	
	2

output to (See SCREEN DUMP on page 17-2)

Selects the device to which the instrument should output. If using a port, check the GPIB & RS232 menu to make sure that the settings are correct.

The device can be either a port (RS232, GPIB, Centronics) to which a plotter or printer is connected, a storage unit, or the internal printer. The list of devices shows the options installed in the instrument.

When copying to a storage unit, a file name will be assigned automatically, following the rules set out in the file-naming section.

page feed

Select **On** to start on a new page each time the SCREEN DUMP button is pressed.

plotter/printer/protocol (See SCREEN DUMP on page 17-2)

Use the menu buttons to select the appropriate driver.

Note: Press the SCREEN DUMP button on the front panel to make a copy of the current screen display.

plot size (for plotters only)

Selects the desired size: A4 (11" x 8.5"), A5 (8.5" x 5.5").

pen number (for plotters only)

Selects the number of pens installed on the plotter. The oscilloscope assumes the pens are loaded consecutively in the lower slots.

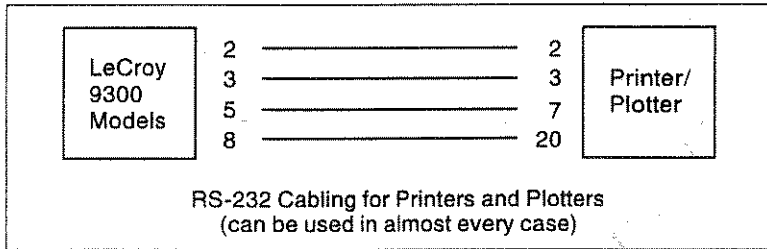

INTERNAL PRINTER SETUP MENU (Optional)

HARDCOPY

output to

Int. Printer

Card

Floppy

GPIB

RS232

auto print

Off On

cm/division

1	2
5	10
20	50
100	200

output to

Select **Internal Printer**.

auto print

When set to "On", generates a hardcopy of the screen to the internal printer after every acquisition.

cm/division

Select the appropriate expansion factor.

Note: A "persistence" trace cannot be expanded. Also, cursors do not show on an expanded printout.

MENU CONTROLS

TIME/DATE MENU

TIME/DATE
SET CLOCK FORWARD ONE HOUR (SPRING)
SET CLOCK BACKWARD ONE HOUR (FALL)
LOAD CHANGES NOW
Hour Min Sec 14:51:12
Day Mnth Year 29 MAR 1993

SET CLOCK...(SPRING)

Press this button to switch to summer time.

SET CLOCK...(FALL)

Press this button to switch to winter time.

LOAD CHANGES NOW

Activates the changes made with the "Hour/Min/Sec" and "Day/Mnth/Year" buttons and knobs.

Hour/Min/Sec

Press the menu button to toggle between "hour", "minutes", and "seconds". Use the menu knob to adjust the corresponding value.

Day/Mnth/Year

Press the menu button to toggle between "day", "month", and "year". Use the menu knob to adjust the corresponding value.

GPIB & RS232 MENU

GPIB & RS232	
Remote Control from	GPIB RS232
RS232 Mode	7-bit 8-bit
Parity	none odd even
Stop bits	1 2
Baud Rate	300 1200 2400 4800 9600 19200
GPIB Device (Address)	4

Remote Control from

Selects the port for remote control.

Note: When RS-232 is selected, the GPIB interface is in "Talk Only" mode.

RS232 Mode

Selects 7-bit or 8-bit mode for RS-232 communication.

Parity

Selects the parity for RS-232 communication.

Stop bits

Selects the number of stop bits for RS-232 communication.

Baud Rate

Selects the appropriate baud rate, using the attributed menu knob.

GPIB Device (Address)

Selects the appropriate GPIB address.

Note: Any change becomes immediately effective.

RS-232-C CONNECTOR

The RS-232-C port on the rear panel can be used for remote oscilloscope operation, as well as for direct interfacing of the oscilloscope to a hardcopy device to produce copies of displayed waveforms and other screen data.

While a printer or plotter unit is connected to the oscilloscope, its RS-232-C port can be computer controlled from a host computer via the GPIB port. The oscilloscope's built-in drivers allow hard copies to be made without an external computer.

RS-232-C connector pin assignments:

DB9 Pin #		Description
3	T × D	Transmitted data (from the oscilloscope).
2	R × D	Received data (to the oscilloscope).
7	RTS	Request to send (from the oscilloscope). If the software Xon/Xoff handshake is selected, it is always TRUE. Otherwise (hardware handshake) it is TRUE when the oscilloscope is able to receive characters and FALSE when the oscilloscope is unable to receive characters.
8	CTS	Clear to send (to the oscilloscope). When TRUE, the oscilloscope can transmit; when FALSE, transmission stops. It is used for the oscilloscope output hardware handshake.
4	DTR	Data terminal ready (from the oscilloscope). Always TRUE.
5	SIG GND	Signal ground.

This corresponds to a DTE (Data Terminal Equipment) configuration.

MASS STORAGE FILE SYSTEM

The mass storage utilities menu contains the user controls for the mass storage file system. This system supports storage and retrieval of data files to and from memory cards, floppy disks and removable hard disk media. .

Memory Card Format

The Memory Card's structure, based on the PCMCIA II / JEIDA 4.0 standard, consists of a DOS partition containing files as in any DOS floppy or hard disk.

When the card is formatted by the oscilloscope it is segmented in contiguous sectors of 512 bytes each. The oscilloscope does not support error detection algorithms such as CRC's or checksum that are inserted between the sectors. In this case, the oscilloscope may still be able to read the card but be unable to write to the card.

Floppy Disk Format

The floppy supports DOS 1.44 MB and 720 kB formats. .

Hard Disk Format

The hard disk structure is based on the PCMCIA III / JEIDA 4.0 standard. The media is arranged as a DOS partition containing files as in any DOS floppy or hard disk.

The hard disk format uses 512 bytes per sector and 4 sectors per cluster. One cluster is the minimum file size, i.e. any files of smaller than 2048 bytes in size will still use one cluster's allocation of 2048 bytes of disk space.

Subdirectories

All files are written to and read from the media from the current working directory. The default name of the working directory is LECROY_1.DIR. This directory is automatically created when the media is formatted. If the media is formatted elsewhere - for instance on a PC - the directory will be created the first time a file is stored to the memory card, floppy disk or hard disk. .

The working directory can be changed to any valid DOS directory name, using the file-name preferences menu. All working directories are created as sub-directories from the root directory.

The maximum number of files allowed in any one directory is 2400.

File-naming Conventions

As in MS-DOS, the file name can take up to 8 characters followed by an extension of 3 characters.

A file is treated as:

- a panel setup if its extension is PNL.
- a waveform if its extension is a 3-digit number.
- a waveform template if its extension is TPL.
- a hardcopy if its extension is TIF, BMP, PRT or PLT.

If the file you are storing carries the same name as a file already on the media, the old file will be deleted.

The instrument has a pre-defined naming convention for the 8-character file names and directory names. These default names can be customized by the user. The file-naming conventions are shown in the table below :

Type	Default Name	Customized Name
Manually stored waveform files	Stt.nnn	xxxxxxxx.nnn
Automatically stored waveform files	Att.nnn	xxxxxxxx.nnn
Panel files	Pnnn.PNL	xxxxnnnn.PNL
Hardcopy files	Dnnn.TIF Dnnn.BMP Dnnn.PRT Dnnn.PLT	xxxxnnnn.TIF xxxxnnnn.BMP xxxxnnnn.PRT xxxxnnnn.PLT
Template files	LECROYvv.TPL	Cannot be changed
Directory name	LECROY_1.DIR	xxxxxxxx

Where:

'x' is any legal DOS file-name character.

'tt' defines the trace name of C1, C2, C3, C4, TA, TB, TC, TD.

'nnn' denotes a 3-digit decimal sequence number starting at 001 that is automatically assigned.

'vv' is the template version number. If the version is 2.1 for example, the template will be saved as LECROY21.TPL.

Extension 'TIF' or 'BMP' denotes hardcopy graphics image files.

Extension 'PLT' denotes hardcopy plotter files.

Extension 'PRT' denotes hardcopy printer files.

Auto-Store Waveform File Naming

The default notation for waveform files is Stt.nnn for manually stored files and Att.nnn for automatically stored files.

The file's first letter A stands for an auto-stored file, while S stands for an individually stored file.

When automatically generating a file name, the system uses the assigned name plus a 3-digit sequence number. If the assigned waveform name is of the default 'Stt' form (i.e. SC1, STB etc) then the name will be modified to the form 'Att' (i.e. AC1, ATB etc). All other user-assigned names will be used as entered.

More on Auto-Stored Files

If the "Fill" option is selected (see **Auto-Store** on page 20-1) and default names are used, the first waveform stored will be Axx.001, the second Axx.002, and so on until the media is full, until the file number reaches 999, or there are more than 2400 files in the current working directory.

If the "Wrap" option is selected, the oldest auto-stored waveform files will be deleted whenever the media becomes full. Remaining auto-stored waveform files are renamed, the oldest group of files being named "Axx.001", the second oldest "Axx.002", etc.

The current sequence number is deduced from inspection of all file names in the working directory, regardless of file type (panel, hardcopy or waveform). The highest occupied numeric file-name extension of the form 'nnn' is determined and the next highest number is used as the current generation number for storage operations.

Deleting Files

When deleting a file generation, all files with the designated 3-digit sequence number as the file-name extension will be deleted, regardless of file type.

Media Size/Storage Availability

The mass storage file system indicates media size and storage availability in kbytes where 1 kbyte = 1024 bytes. Many media manufacturers specify the available storage in Mbytes where 1 Mbyte = 1 million bytes. This results in an apparent mismatch in specified vs. actual media storage availability when in fact the storage availability in bytes is identical.

Write Protect Switch

At the back of the memory card or the floppy you will find a write-protection switch that may be activated to prevent writing to the card or floppy. A "Device is Write Protected" message will then be displayed on the upper part of the grid whenever the media is accessed for writing.